

Decontamination
Health Technical Memorandum
01-05: Decontamination in
primary care dental practices



2013 edition

DH INFORMATION READER BOX

Policy	Clinical	Estates
HR / Workforce	Commissioner Development	IM & T
Management	Provider Development	Finance
Planning / Performance	Improvement and Efficiency	Social Care / Partnership Working

Document Purpose	Best Practice Guidance
Gateway Reference	<u>18872</u>
Title	HTM 01-05: Decontamination in primary care dental practices. 2013 Version
Author	DH
Publication Date	31 March 2013
Target Audience	
Circulation List	
Description	This document is a guide for those conducting decontamination in primary care dental practices
Cross Ref	n/a
Superseded Docs	HTM 01-05: Decontamination in primary care dental practices. 2009 version
Action Required	n/a
Timing	n/a
Contact Details	Philip Ashcroft Principal Buildings & Facilities Management Services Engineer Department of Health, 2W59 Quarry House, Quarry Hill, Leeds, LS2 7UE 0113 2545794
For Recipient's Use	

Decontamination

Health Technical Memorandum 01-05: Decontamination in primary care dental practices

2013 edition

© Crown copyright 2009, 2013

This document/publication is not covered by the HMSO
Click-Use Licences for core or added-value material.

If you wish to re-use this material, please send your application
to:

Copyright applications
The Copyright Unit
Office of Public Sector Information
Information Policy Team
Kew
Richmond
Surrey
TW9 4DU
e-mail: licensing@opsi.gov.uk

First published 2009; second edition 2013

Preface

About Health Technical Memoranda

Health Technical Memoranda (HTMs) give comprehensive advice and guidance on the design, installation and operation of specialised building and engineering technology used in the delivery of healthcare.

The focus of Health Technical Memorandum guidance remains on healthcare-specific elements of standards, policies and up-to-date established best practice. They are applicable to new and existing sites, and are for use at various stages during the whole building lifecycle.

main source of specific healthcare-related guidance for estates and facilities professionals.

The core suite of nine subject areas provides access to guidance which:

- is more streamlined and accessible;
- encapsulates the latest standards and best practice in healthcare engineering, technology and sustainability;
- provides a structured reference for healthcare engineering.

Figure 1 Healthcare building life-cycle

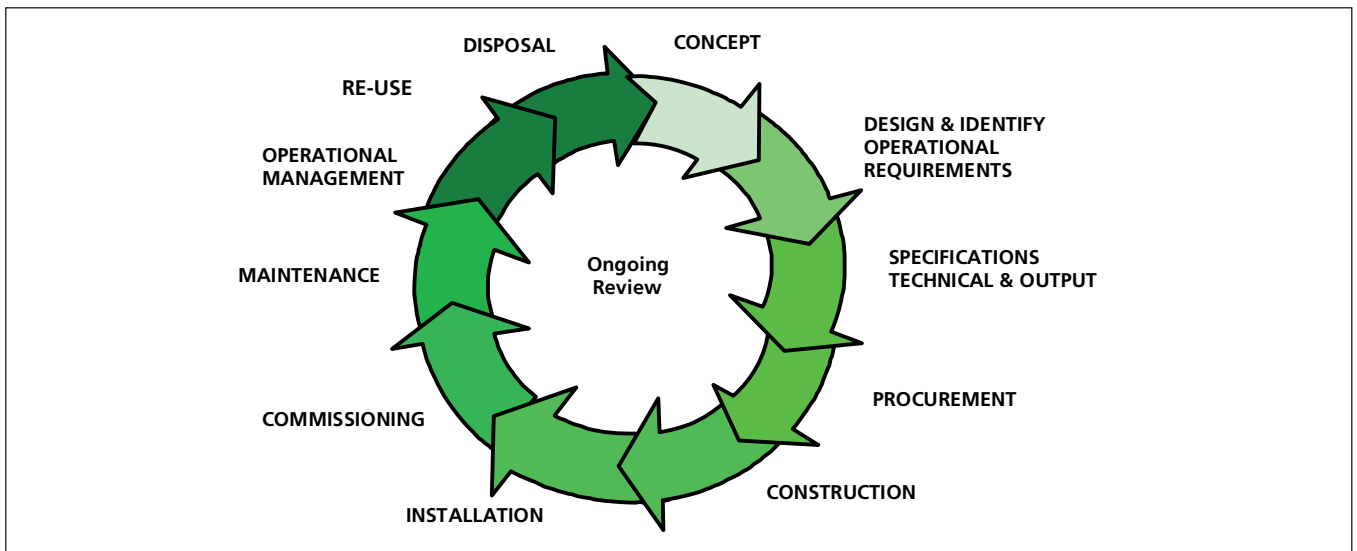

Healthcare providers have a duty of care to ensure that appropriate governance arrangements are in place and are managed effectively. The Health Technical Memorandum series provides best practice engineering standards and policy to enable management of this duty of care.

It is not the intention within this suite of documents to unnecessarily repeat international or European standards, industry standards or UK Government legislation. Where appropriate, these will be referenced.

Healthcare-specific technical engineering guidance is a vital tool in the safe and efficient operation of healthcare facilities. Health Technical Memorandum guidance is the

Structure of the Health Technical Memorandum suite

The series contains a suite of nine core subjects:

Health Technical Memorandum 00

Policies and principles (applicable to all Health Technical Memoranda in this series)

Health Technical Memorandum 01

Decontamination

Health Technical Memorandum 02

Medical gases

Health Technical Memorandum 03
Heating and ventilation systems

Health Technical Memorandum 04
Water systems

Health Technical Memorandum 05
Fire safety

Health Technical Memorandum 06
Electrical services

Health Technical Memorandum 07
Environment and sustainability

Health Technical Memorandum 08
Specialist services

Some subject areas may be further developed into topics shown as -01, -02 etc and further referenced into Parts A, B etc.

Example: Health Technical Memorandum 06-02 Part A will represent:

Electrical Services – Electrical safety guidance for low voltage systems

In a similar way Health Technical Memorandum 07-02 will simply represent:

Environment and Sustainability – EnCO₂de.

All Health Technical Memoranda are supported by the initial document Health Technical Memorandum 00 which embraces the management and operational policies from previous documents and explores risk management issues.

Some variation in style and structure is reflected by the topic and approach of the different review working groups.

DH Estates and Facilities Division wishes to acknowledge the contribution made by professional bodies, engineering consultants, healthcare specialists and NHS staff who have contributed to the production of this guidance.

Figure 2 Engineering guidance

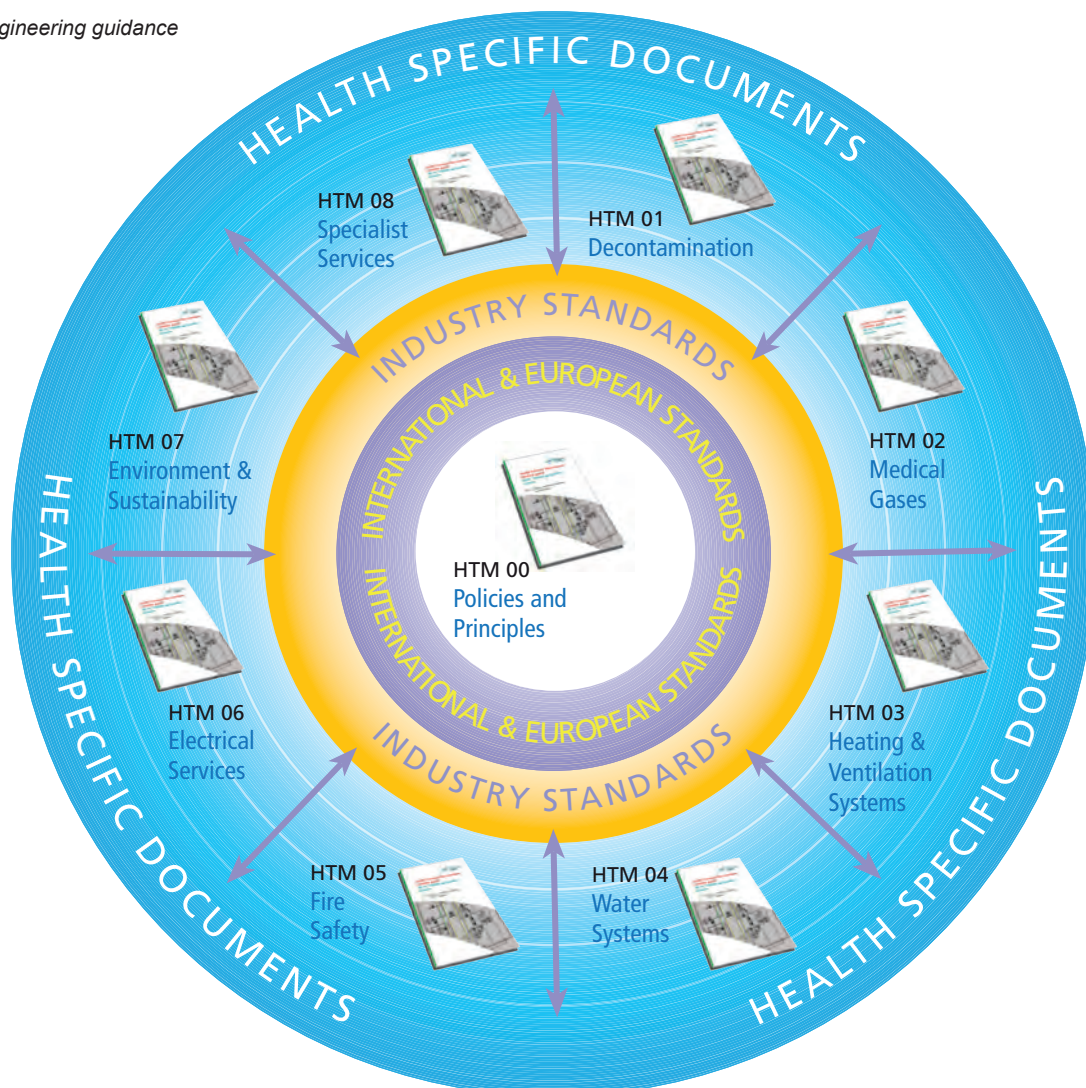

Executive summary

Preamble

This document forms part of the Health Technical Memorandum 01 Decontamination series. Other parts include:

- Choice Framework for local Policy and Procedures 01-01: Management and decontamination of surgical instruments (medical devices) used in acute care
- Health Technical Memorandum 01-02: Decontamination in laboratories
- Health Technical Memorandum 01-03: Decontamination in pharmacies
- Choice Framework for local Policy and Procedures 01-04: Decontamination of linen for health and social care
- Choice Framework for local Policy and Procedures 01-06: Decontamination of flexible endoscopes
- Health Technical Memorandum 01-07: Decontamination in primary care NHS trusts.

Structure

This document includes the following three sections:

- Section 1: Decontamination policy and foreword
- Section 2: Advice to dentists and practice staff (local decontamination)
- Section 3: Engineering, technology and standards.

Aim of the guidance

Health Technical Memorandum 01-05 is intended to progressively raise the quality of decontamination work in primary care dental services by covering the decontamination of reusable instruments within dental facilities.

Who should use this guidance?

Health Technical Memorandum 01-05 will be of interest to all staff involved in decontamination in primary care dental services.

It is intended to be used, or referred to, by all members of a dental team providing primary care dental services (that

is, dentists and support staff as well as engineering staff providing services in key areas).

Reference to other parts of the Choice Framework for local Policy and Procedures 01 series may be necessary (on a limited basis only).

2013 edition of Health Technical Memorandum 01-05

This section does not give an exhaustive list of the amendments made to the 2009 edition but rather summarises the rationale behind this new edition, in particular the main policy changes.

This 2013 edition of Health Technical Memorandum 01-05 reflects the consensus on patient safety in the area of storage of dental instruments. Consequently, this review of the guidance on storage times (in particular, see paragraphs [2.4k](#), [4.22](#) and [4.26–4.27](#)) has been carried out in advance of the planned revision of Health Technical Memorandum 01-05.

It is recognised that potentially infectious recontamination of sterilized dental instruments is event-related rather than time-dependent. Within dental practices, there is a rapid turnaround of the most regularly used dental instruments. The 2009 edition was not helpful in the management of these frequently used instruments.

The rationale for this change is that these dental instruments are used in contaminated body areas. Any environmental contamination that takes place would have a minimal impact on patient safety compared with contamination with another patient's blood or body fluid, which would be a significant hazard to patients. Thus, the emphasis is on ensuring effective decontamination and preventing contamination with another patient's blood and body fluid rather than on preventing environmental contamination of sterilized instruments.

The guidance document has also been updated to reflect the changes to the NHS infrastructure following the Health and Social Care Act 2012.

Acknowledgements

Allan Hilderley Medicines & Healthcare products Regulatory Agency

Christine Arnold British Dental Association

Daniel McAlonan British Dental Association

Esther Dias Infection Prevention Officer and Decontamination Lead, NHS Bromley

Geoff Ridgway Clinical microbiologist

Hugh Bennett Deputy Chief Dental Officer for Wales

Jimmy Walker Health Protection Agency

Ken Toal Health Estates, Northern Ireland

Lesley Derry British Dental Association

Lester Ellman General Dental Practitioner

Margie Taylor Chief Dental Officer for Scotland

Martin Jones Infection Prevention Society

Murray Devine Safety Strategy Lead, Healthcare Commission

Paul Gray NHS Business Services Authority, Dental Services Division

Paul Langmaid Chief Dental Officer for Wales

Stuart Johnston British Dental Association

DH Working Group on Water Quality in Use and Decontamination of Surgical Instruments.
Chairman Nigel Tomlinson

Engineering and Science Advisory Committee on the decontamination of surgical instruments.
Chairman Mike Painter

Internal consulting group

Barry Cockcroft Chief Dental Officer for England

Jerry Read Section Head, Dental and Eye Care Division

Serbjit Kaur Head of Quality and Standards, Dental and Eye Care Services

Ruth Gasser Department of Health

Ian Rowlan Senior Engineer, Department of Health

Philip Ashcroft Principal Buildings and Facilities Management Services Engineer, Department of Health

Nigel Tomlinson Principal Scientific Adviser, Department of Health

2013 edition working group

Daniel McAlonan British Dental Association

Jimmy Walker Health Protection Agency

Serbjit Kaur Head of Quality and Standards, Dental and Eye Care Services

Peter Hoffman Health Protection Agency

Paul Gray NHS Business Services Authority, Dental Services Division

Philip Ashcroft Principal Buildings and Facilities Management Services Engineer, Department of Health

Except where stated, all photographs are published by kind permission of Bromley Primary Care Trust

Contents

	Preface	
	Executive summary	
	Preamble	
	Structure	
	Aim of the guidance	
	Who should use this guidance?	
	2013 edition of Health Technical Memorandum 01-05	
	Acknowledgements	
	Internal consulting group	
	2013 edition working group	
SECTION 1: DECONTAMINATION POLICY AND FOREWORD		1
Chapter 1	Policy and foreword	
	(Barry Cockcroft, Chief Dental Officer)	2
	Registration	
	“Essential quality requirements” and “best practice”	
	Progression towards best practice	
	Prion decontamination	
	Infection control policy	
	Training and education	
	Scope, status and structure of Health Technical Memorandum 01-05	
	Exclusions	
	Relationship to other sources of information and guidance	
	Further guidance	
SECTION 2: ADVICE TO DENTISTS AND PRACTICE STAFF		9
Chapter 2	Essential quality requirements and best practice	10
	Decontamination of instruments –	
	an overview	
	Compliance	
	Essential quality requirements	
Chapter 3	Cleaning instruments	16
	Introduction	
	General requirements for cleaning methods	
	Automated cleaning: washer-disinfectors	
	Using a washer-disinfector	
	Records	
	Considerations for cleaning handpieces	
	Automated cleaning: ultrasonic cleaning	
	Ultrasonic cleaning procedure	
	Manual cleaning	
	Avoiding instrument damage	
	Cleaning procedure summary	
	Rinsing of instruments after cleaning and or disinfection	

	Inspection and care of instruments before sterilizing	
	Handpiece care	
Chapter 4	Sterilization	22
	Types of sterilizer	
	Dental handpieces	
	Benchtop sterilizers	
	Use and testing of benchtop sterilizers	
	Daily testing and housekeeping tasks	
	Packaging and related decontamination strategy	
	Storage of sterilized instruments/devices	
Chapter 5	Setting up a decontamination area	29
	Physical segregation	
Chapter 6	General hygiene principles	33
	Hand hygiene	
	Drying of hands	
	Skin care	
	Facilities and procedures for hand-washing	
	Personal protective equipment for decontamination processes	
	Gloves	
	Disposable plastic aprons	
	Face and eye protection for decontamination procedures	
	Clothing, uniforms and laundry	
	Removal of PPE	
	Surface and equipment decontamination	
	General	
	Environmental conditions	
	Surfaces and equipment – key design issues	
	Decontamination equipment	
	Cleaning protocols and techniques	
	Decontamination of treatment areas	
	Dental unit water lines (DUWLs)	
	General	
	DUWLs	
Chapter 7	Impressions, prostheses and orthodontic appliances	42
SECTION 3: ENGINEERING, TECHNOLOGY AND STANDARDS		43
Chapter 8	Regulatory framework and compliance	44
	BS/EN/ISO Standards	
	DH guidelines	
Chapter 9	Staff roles and responsibilities in decontamination	46
Chapter 10	Procurement of decontamination equipment and instruments	48
	Determining the load to be processed	
	Decontamination equipment: washer-disinfectors and sterilizers	
	Decontamination equipment: ultrasonic cleaners	
	Specifications	
	Selecting instruments	
	Policy on new reusable instruments	
Chapter 11	Decontamination equipment: general guidance on maintenance and testing	53
	Maintenance and servicing	
	Validation and testing	
	Documentation	
Chapter 12	Installation, validation, maintenance and testing of sterilizers	55
	Maintenance and servicing	

	Validation and testing	
	Periodic tests	
Chapter 13	Installation, validation, maintenance and testing of washer-disinfectors	57
	Maintenance and servicing	
	Validation	
Chapter 14	Installation, validation, maintenance and testing of ultrasonic cleaners	59
	Maintenance and servicing	
	Validation	
	Periodic tests	
Chapter 15	Additional information on test procedures (in addition to those provided in the Standards)	61
	Automatic control test	
	Method	
	Ultrasonic activity test	
	Method	
	Safety checks	
	Weekly checks	
	Yearly checks	
Chapter 16	Approach and protocol for manual cleaning	63
	Cleaning procedure for dental instruments	
Chapter 17	Steam and water quality	65
	Steam	
	Quality of input water	
	Conditions of storage and frequency of change	
	Water	
	Cleaning	
	Final rinsing	
	Detergents	
Chapter 18	The use of lubricants	66
Chapter 19	Hot and cold water systems and dental unit water lines	67
	Safe hot water temperature	
	Utilisation	
	Flushing dental unit water lines (DUWLs)	
	Decommissioning of DUWLs	
	Recommissioning of DUWLs	
	Maintenance policy	
	Contract maintenance	
	Emergency action	
	Documentation	
	As-fitted drawings	
	Record-keeping	
	Water supply hygiene	
	Water treatment	
	Purging the systems	
	Ozone and ultraviolet treatment	
	Water storage	
	Cold water distribution system	
	Drinking water	
	Instantaneous water heaters for single or multi-point outlets	
	Safe hot water delivery devices	
	Materials of construction	
	Temperature control regimen	
	Point-of-use filtration	
	Summary checklist	

Microbiological monitoring	
Appendix 1 – Hand hygiene policy	76
Appendix 2 – Examples of logbook pages	78
References	83
Northern Ireland references, equivalents and variations	86

Section 1: Decontamination policy and foreword

1 Policy and foreword (Barry Cockcroft, Chief Dental Officer)

Patients deserve to be treated in a safe and clean environment with consistent standards of care every time they receive treatment. It is essential that the risk of person-to-person transmission of infections be minimised as much as possible.

This document has been produced after wide consultation and reflects our commitment to improving standards in dental practices.

We believe that – by building on existing good practice – this guidance can help us to deliver the standard of decontamination that our patients have a right to expect.

The policy and guidance provided in this Health Technical Memorandum are aimed at establishing a programme of continuous improvement in decontamination performance at a local level. The guidance suggests options to dental practices within which choices may be made and a simple progressive improvement programme established. Following the original publication of this guidance in 2009, all primary care dental practices should now be working at or above the **essential quality requirements** described in this guidance.

This guidance is intended to support and advance good practice throughout primary care dentistry including that delivered by general dental practices, salaried dental services and where primary care is delivered in acute settings.

Registration

All dental practices are required to be registered with the Care Quality Commission. This is the independent regulator of health and social care services in England. In order to be registered, providers must meet a set of registration requirements including one on cleanliness and infection control.

Guidance on meeting this requirement is set out in the '[Health and Social Care Act 2008: Code of Practice on the prevention and control of infections and related guidance](#)'. This Code takes due note of this guidance and does not impose any additional burdens with respect to decontamination in primary care dental practices. (For further information, see [page 45](#).)

Introduction

- 1.1 This document is a guide for those conducting decontamination at a local level – that is, within the dental practice itself. However, this policy statement respects the option to transfer instruments/medical devices to other organisations for reprocessing under the Medical Devices Regulations 2002.
- 1.2 To help dental practices to improve their decontamination procedures, this document describes the specific benchmarks by which compliance with
 - **essential quality requirements** and
 - **best practice**can be achieved and demonstrated.
- 1.3 The requirements described in this guidance are intended as a clear indication of good practice and designed to exert upward pressure on the performance of dental practices. They will help to demonstrate to patients and those observing quality standards in dentistry that the local provider

of a dental service is capable of operating in a safe and responsible manner with respect to decontamination of instruments and dental equipment. **Where new practices are commissioned or new premises contemplated, it is advised that the full best practice provisions of this guidance be utilised wherever reasonably practicable.**

- 1.4 The guidance provided here follows the essential principles given in the ‘Health and Social Care Act 2008: Code of Practice on the prevention and control of healthcare associated infections and related guidance’ (the [Code of Practice](#)). This requires that effective prevention and control of healthcare-associated infection be embedded in everyday practice. For this reason, the guidance is written with emphasis on practical and readily implemented measures. Appendix B of the Code of Practice refers specifically to the requirements for dental practices.
- 1.5 The 2010 revision to the Code of Practice establishes a duty to provide and maintain a clean and appropriate environment for healthcare within which a specific requirement for effective arrangements for the appropriate decontamination of instruments and other equipment is given. This guidance is designed to assist all primary care dental providers (including salaried dental services) in meeting these requirements.
- 1.6 ‘Clean, safe care – reducing infections and saving lives’ refers to the need for high-quality environmental cleaning and decontamination as vital components in reducing rates of infection.

“Essential quality requirements” and “best practice”

- 1.7 Every practice should be capable of meeting the **essential quality requirements**, that is:
- Regardless of the technology used, the cleaned instruments, prior to sterilization, should be free of visible contaminants when inspected. Instruments should be reprocessed using a validated decontamination cycle including: cleaning/washing (in terms of manual cleaning, this includes having a written protocol – see [Chapter 16](#)); a validated steam sterilizer, and at the end of the reprocessing cycle they should be in a sterilized state.

- Reprocessed dental instruments should be stored in such a way as to ensure restraint of microbiological recolonisation. These measures should be backed by careful controls on the storage times to which instruments that are less frequently used are subject.
- Practices should audit their decontamination processes every six months using an audit tool (the use of the Infection Prevention Society/DH audit tool is strongly recommended). This can be downloaded from www.ips.uk.net at the “[resources/dental audit tool](#)” section of the website.
- Practices should have in place a detailed plan on how the provision of decontamination services will move towards **best practice**.

An expanded list of **essential quality requirements** is given in [paragraph 2.4](#).

- 1.8 To demonstrate **best practice**, further improvements are required in three main areas:
- A cleaning process that should be carried out using a validated automated washer-disinfector.
 - The environment in which decontamination is carried out should be such as to minimise the risk of recontamination of instruments and the possibility of generating aerosols, which may reach patients or unprotected staff. For **best practice**, the decontamination facilities should be clearly separate from the clinical treatment area. This implies the use of a separate room or rooms for the accommodation of clean (output) and dirty (input) work. In these facilities, the room(s) should be used for this purpose only and access should be restricted to those staff performing decontamination duties. However, plant and equipment not necessarily used for decontamination may be located in these rooms (but preferably in the dirty room) provided it can reasonably be shown that the devices do not conflict with the requirement for a clean environment.
 - The storage of reprocessed dental instruments in a simple but carefully designed facility clearly separate from the clinical treatment area is an important **best practice** improvement. The facility should take account of the need to reduce recontamination of sterilized instruments and also make the identification/selection of



For best practice, the clinical treatment area should be clearly separate from the decontamination facilities

instruments easy. This storage facility will ordinarily be part of the clean area within the decontamination room(s).

- 1.9 The overall aim is to achieve a reprocessed medical device (dental instrument) that is fully compliant with the “essential requirements” of the Medical Devices Regulations 2002. This implies that the instrument should be:
- clean and sterilized at the end of the decontamination process; and
 - maintained in a clinically satisfactory condition up to the point of use.
- 1.10 Following the guidance in this document will help to achieve a satisfactory level of risk control together with equivalent compliance with the “essential requirements” of the regulations.

Progression towards best practice

- 1.11 Not all practices will, at present, be in a position to adopt **best practice** recommendations. However, every practice will need to assess the improvements they need to undertake to move towards these and prepare a plan to implement the changes.
- 1.12 No schedule for attainment of **best practice** is provided in this guidance for the present. It is recognised that not only are improvements in premises and equipment required to achieve higher standards, but also changes in practice management and the culture in which patients are treated by the dental team are necessary.

“Sterile” and “sterilized”

As the environment in which dental instruments are used is not sterile, it follows that dental instruments will not be sterile at the point of use. (They should, however, be in a sterile state at the end of the decontamination process when the sterilizer door is opened.)

Accordingly, this guidance accepts that dental instruments may be defined as “sterilized” rather than “sterile” at the point and time of use (a somewhat different approach from that in invasive surgical procedures).

In some instances, the decontamination process may not generate full sterilization, for example in the reprocessing of dental handpieces; however, the guidance will nevertheless seek to raise standards and minimise infection risk.

- 1.13 This guidance is based upon a principle of continuous improvement in the quality of decontamination practices and the environment used. Where dental practices use the same room for patient treatment and decontamination (**essential quality requirements**), they should have a plan in place that facilitates a separate and controlled decontamination room. This plan will normally also contain statements on staff training and development to suit work in a dedicated decontamination room or suite.
- 1.14 In addition, the plan should realistically outline the way forward in relation to **best practice** requirements, for example:
- measures to purchase and incorporate a washer-disinfector;
 - the separation of decontamination processes from the patient treatment area.

Prion decontamination

- 1.15 Recent research has indicated that a low level of prion contamination may theoretically be present on some instruments following contact with dental tissues. This applies if these instruments have previously been used in the care of a prion disease carrier who may exhibit no symptoms and may indeed not go on to develop the disease. For those tissues where evidence suggests this risk is most pronounced, the Chief Dental Officer for England has published requirements for endodontic files

and reamers (see [paragraph 2.18](#)). Other instrument or device types for which a reliable cleaning regime is not available should also be considered for replacement by single-use types or by the single use of reprocessible instruments. Information regarding risk in this important area is contained in ‘Potential vCJD transmission risks via dentistry: an interim review’ (December 2007).

Note

Where patients indicate that they are in a high-risk group, guidance provided by the Advisory Committee on Dangerous Pathogens – Transmissible Spongiform Encephalopathy Working Group (ACDP-TSE WG) should be followed (<http://www.dh.gov.uk/health/2012/11/acdp-guidance>). The guidance suggests that special precautions beyond full instrument decontamination will not be necessary.

- 1.16 For all other instruments used in dentistry, the risk of prion transmission will be usefully reduced by compliance with the decontamination procedures described in this Health Technical Memorandum. This statement is based on various studies (conducted on behalf of DH) that examined the effect of steam sterilization on prion infectivity. These studies showed that the steam sterilization methods described in this guidance provide a useful level of deactivation of prion infectivity. While this would not be significant in high-risk tissue surgery, the effect is large enough to be of significance in dentistry (excluding, that is, endodontic procedures as mentioned in [paragraph 1.15](#)). In addition, there is a risk of prion transmission through protein contamination of instruments, hence the measures outlined in this guidance to improve washing and disinfection of dental instruments.
- 1.17 Currently there is no recognised process that can fully deactivate prion protein in the sense of removing any foreseeable level of contamination. In this Health Technical Memorandum, the cleaning process and its ability to remove protein in tandem with a validated steam sterilization procedure is emphasised, as this is known to at least reduce the risk of prion transmission through dental instruments.

Infection control policy

- 1.18 All dental practices should have an infection control policy in place and available for external inspection.
- 1.19 The infection control policy statement for each practice should indicate full compliance with the **essential quality requirements** (as outlined in [paragraphs 2.6–2.7](#)). In addition, a written assessment of the improvements the practice needs to make in order to progress towards meeting the requirements for **best practice** should be available together with an implementation plan (as outlined on [page 15](#)).

Note

This statement is subject to staged implementation and to local constraints (for example, the physical inability to provide a separate room).

- 1.20 Infection control needs to include all aspects of the running of a dental practice: from attention to personal hygiene – hand-washing, masks, protective clothing – to the cleaning and sterilization of instruments and the maintenance of the equipment.
- 1.21 Practices need to have a process in place to clearly identify the date of reprocessing of wrapped instruments ([paragraph 2.4k\(i\)](#)). The record should show the date of decontamination or the expiry date.

Training and education

- 1.22 Training and education in the processes of pathogen control, decontamination, cleaning and hygiene (including hand hygiene), exposure to blood-borne viruses, and infection risk reduction, including waste disposal, should be part of staff induction programmes. They are key aspects of patient safety and service quality. Accordingly the provision of training and competency records is a key requirement. As part of verifiable continuous professional development (CPD), professionals working in this area will receive not less than five hours' training in this area over a period of five years.

Scope, status and structure of Health Technical Memorandum 01-05

- 1.23 Health Technical Memorandum 01-05 relates to locally conducted decontamination procedures, which are the most common method of decontamination in primary dental care. As such, this includes all work where the end-user and the persons conducting decontamination are employees of the same organisation working in the same or related premises. Ordinarily this will be a general dental practice or salaried primary care dental services.
- 1.24 Where practices choose to make use of an external service – such as a central sterile services department – which is fully compliant with the Medical Devices Regulations 2002 and is registered with the Medicines and Healthcare products Regulatory Agency (MHRA), the guidance contained in Choice Framework for local Policy and Procedures 01-01 will be appropriate to that service.
- 1.25 The policy clarification from DH ('Decontamination of reusable medical devices in the primary, secondary and tertiary care sectors (NHS and Independent providers) – 2007 clarification and policy summary') states that local decontamination should meet with the appropriate "essential requirements" of the Medical Devices Regulations 2002. This implies that dental practices ensure that their local policies give rise to the production and use of sterilized instruments for use with patients.
- 1.26 This document is divided into three sections:
- Section 1: Decontamination policy and foreword.
This section outlines the policy and principles of decontamination in dental practices, and explains the **essential quality requirements** and **best practice** requirements.
 - Section 2: Advice to dentists and practice staff.
This section gives plain advice to dentists and practice staff on how to meet **essential quality requirements** and achieve **best practice**; how to clean and sterilize instruments; and how to set up a decontamination area within the practice.
 - Section 3: Engineering, technology and standards.
This section gives technical advice to engineering and technical staff, including

Authorised Persons (Decontamination) and Competent Persons (Decontamination).

- 1.27 Where engineering and technical information is provided ([Section 3](#)), references to source standards and evidence are given. However, such references are omitted in [Section 2](#) to aid clarity of presentation and explanation.
- 1.28 **It is important to remember that this is a working document; changes to it may be necessary as new evidence around the methodology of decontamination becomes available.**

Exclusions

- 1.29 This Health Technical Memorandum does not cover the following:
- Decontamination in sterile services departments (SSDs). This is covered in Health Building Note 13.
 - Decontamination in laboratories (covered in the forthcoming Health Technical Memorandum 01-02).
 - Decontamination in pharmacies (covered in the forthcoming Health Technical Memorandum 01-03).
 - Decontamination of linen for health and social care (covered in Choice Framework for local Policy and Procedures 01-04).
 - Decontamination of flexible endoscopes (covered in Choice Framework for local Policy and Procedures 01-06).

Relationship to other sources of information and guidance

- 1.30 The main sources of information used in the preparation of this guidance are listed in the [References](#) section. Readers should ensure they use the latest edition of all building legislation, British Standards, health and safety regulations etc, and give first preference to products and services from sources that have been registered under a quality assurance procedure.

Note

Throughout this guidance, references are made to ISO, EN and BSI Standards. In some instances, these standards have been harmonised so that the content of the output for all three standards institutions is the same. These harmonised standards support the essential requirements of the medical device directives (and their equivalent enactments in UK law).

Where a product or process is stated as compliant with a specified standard this will assist in meeting the appropriate essential requirement of the EU Medical Devices Directives. Where manufacturers do not use the harmonised standard to state compliance, the technical file for the product should identify by what means compliance with that essential requirement is being met. For some medical devices the approval of a Notified Body may be necessary in making the assessment of compliance, with the essential requirements and appropriate standards coupled to the use of a CE marking. The Competent Authority for the MDD structure in the UK is the Medicines and Healthcare products Regulatory Agency (www.mhra.gov.uk/index.htm). Amongst a range of duties, the agency audits the performance of Notified Bodies.

For low-risk category devices the approach is less complex and the manufacturer is simply registered with the Competent Authority.

Further guidance

- 1.31 Professional advice is available from the British Dental Association's 'Infection control – England', which takes full account of Health Technical Memorandum 01-05 (<http://www.bda.org/dentists/advice/practice-mgt/health-safety/ic/index.aspx>).
- 1.32 This 2013 edition of Health Technical Memorandum 01-05 supersedes the 2009 edition and takes account of EN and ISO standards.

**THIS PAGE IS INTENTIONALLY
LEFT BLANK**

Section 2: Advice to dentists and practice staff

2 Essential quality requirements and best practice

Decontamination of instruments – an overview

- 2.1 Decontamination is the process by which reusable items are rendered safe for further use and for staff to handle. Decontamination is required to minimise the risk of cross-infection between patients and between patients and staff.
- 2.2 Decontamination of instruments (also known as reprocessing) is a complex process that involves several stages, including cleaning, disinfection, inspection and a sterilization step. The diagram below summarises how the individual stages ideally link together to complete the process of instrument decontamination.

Compliance

Essential quality requirements

- 2.3 Instruments should be reprocessed using a validated decontamination process including a validated steam sterilizer, and at the end of the reprocessing cycle they should be sterilized.
- 2.4 In maintaining and developing dental decontamination practices, all the following should be included:
- A local infection control policy subject to update as required by the [Code of Practice](#), or at two-yearly intervals, whichever is the shorter.

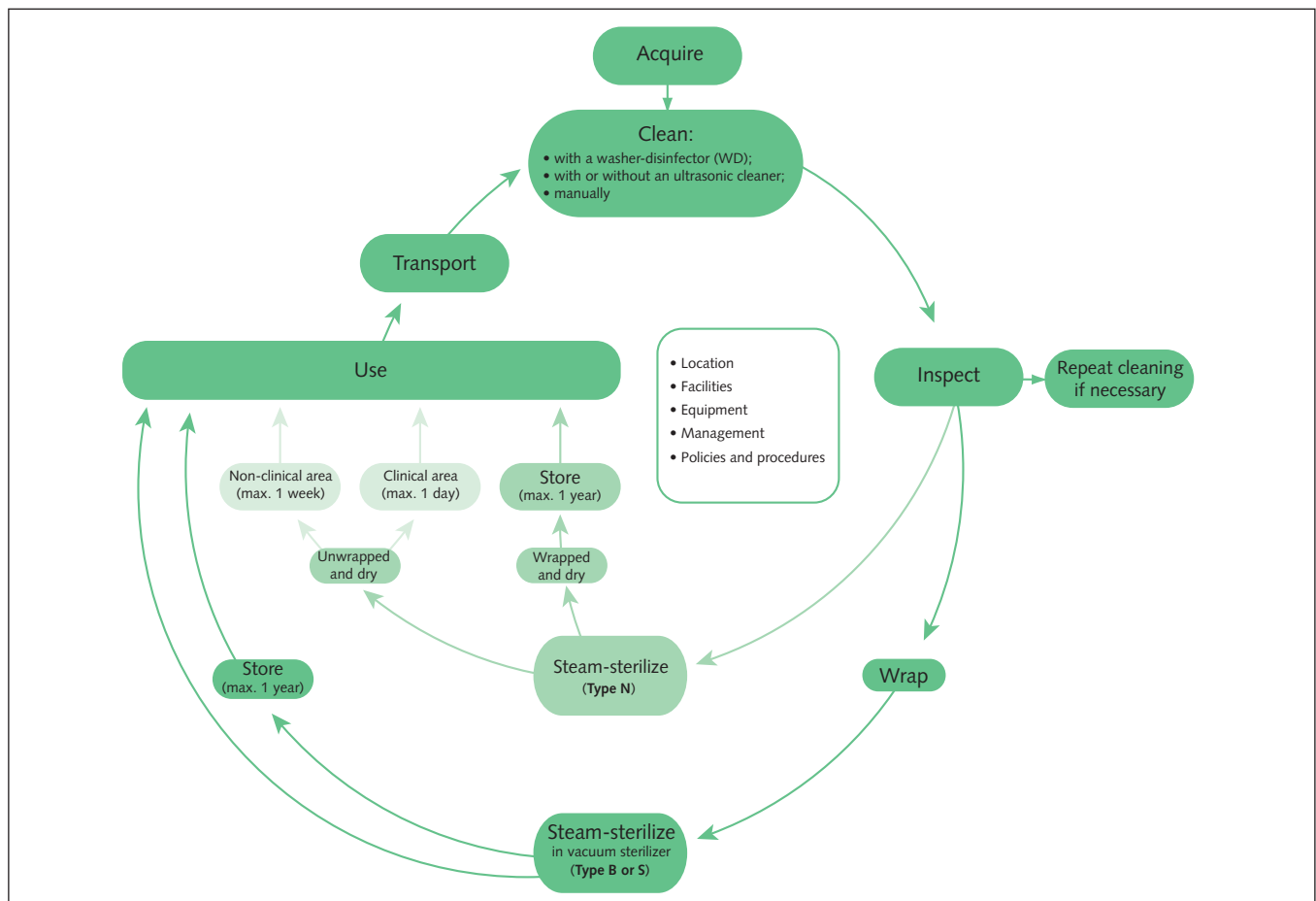

Compliance definitions

Compliance – Essential quality requirements

This terminology is used within this Health Technical Memorandum to define a level of compliance expected as a result of its implementation. Guidance contained within this document will assist dental practices in maintaining these requirements and developing towards higher levels of achievement in this area over time. The use of an audit tool will assist dental practices in reaching the necessary standards (see [paragraph 2.21](#)).

In order to demonstrate compliance with **essential quality requirements**, practices will be expected to provide a statement on plans for future improvement. Details on registration requirements are given in [Chapter 8](#).

Compliance – Best practice

Best practice refers to the full level of compliance that may be achieved immediately or via a documented improvement from **essential quality requirements**.

- b. The above policy should have detailed requirements/procedures for the decontamination of instruments.
- c. The practice should have a nominated lead member of staff responsible for infection control and decontamination.
- d. The storage, preparation and use of materials should take full account of the requirements of the Control of Substances Hazardous to Health (COSHH) Regulations 2002. Particular care should be taken in the storage and preparation for use of decontamination chemical products. Manufacturers' instruction sheets should be consulted for further information. Guidance on COSHH is available from the Health & Safety Executive (<http://www.hse.gov.uk/coshh>).
- e. Practices should have a clear procedure for ensuring appropriate management of single-use and reusable instruments, which safeguards their status. ([Section 3](#) contains detailed guidance on instrument purchase and disposal.)
- f. Reprocessing of dental instruments should be undertaken using dedicated equipment (see [Section 3](#)).
- g. Dedicated hand-washing facilities should be provided.
- h. Cleaning and inspection are key parts of satisfactory dental instrument reprocessing. Instruments may be cleaned using an ultrasonic bath, but this should be covered during use to restrict the release of aerosols. Manual cleaning may also be used. Practices should plan for the introduction of washer-disinfectors. Inspection processes should ensure that the standards of cleaning achieved are visually satisfactory – that is, that instruments are free from particulate contamination, salt deposits or marked discoloration. The use of a simple magnifying device with task lighting is required.
- j. The separation of instrument reprocessing procedures from other activities, including clinical work, should be maintained by physical or temporal means. Decontamination equipment including sterilizers should accordingly be located in a designated area. The layout within this area should reflect the progression from the receipt of dirty, used instruments towards clean instruments sterilized in a specific controlled clean area. In the first instance, where practices are meeting the essential quality requirements defined by this guidance, the designated area for decontamination may be in, or adjacent to, a clinical room. At a later stage of development, more complete separation involving the use of a designated room or rooms will become appropriate (see [Figures 1–3 in Chapter 5](#)).
- k. Instrument storage and wrapping recommendations:
 - (i) **Wrapped instruments may be stored up to 1 year** (see [paragraphs 4.25–4.29](#)):
 - pre-sterilization wrapped if type B or S;
 - post-sterilization wrapped if type N.
 - (ii) **Unwrapped instruments in the clinical area: maximum storage 1 day.** Instruments should be:
 - dry; and
 - protected from contamination, for example in mini-racks placed in cupboards or in covered drawer inserts. Instruments should not be stored on open work surfaces, particularly in clinical areas. It is important that practices have well

developed protocols and procedures in place to prevent contamination of these instruments by ensuring that those required for a particular patient are removed from their protected environment before treatment commences. This eliminates the need to open cupboard doors or drawers during patient treatment. If an instrument does need to be retrieved from a cupboard or drawer during treatment, the practice should have protocols in place to prevent contamination and to ensure that staff hands are clean and that new gloves are donned before handling unwrapped sterilized instruments. Regard all instruments set out for each patient as contaminated after the treatment whether or not they have been used.

Instruments that are kept unwrapped should be reprocessed at the end of the working day, regardless of whether they have been used. Alternatively, instruments can be reprocessed at the beginning of the next working day.

(iii) **Unwrapped instruments in a non-clinical area: maximum storage 1 week.**

Non-clinical area in this context is designated as a clinical area not in current use or in a clean area of a separate decontamination room. Instruments should still be stored as follows:

- dry; and
 - protected from contamination, for example in mini-racks placed in cupboards, or in covered drawer inserts. Instruments should not be placed on open work surfaces.
- m. Develop a quality system approach so that the storage of wrapped instruments does not exceed one year.
- n. Equipment used to decontaminate dental instruments should be fit for purpose and validated. This means that the device should be commissioned, maintained and periodically tested by a Competent Person (Decontamination) or service engineer, that records of maintenance should be kept and that correct functioning should be monitored and recorded (see [Section 3](#)).

- p. The appropriate and controlled disposal of waste is a key aspect of risk control in local dental practices (see [Section 3](#)).
- q. A documented training protocol should be in operation with individual training records for all staff engaged in decontamination (see [Section 3](#) for details).
- r. The practice should carry out an assessment of the changes needed to move from compliance with **essential quality requirements** to compliance with **best practice** requirements.
- s. Staff involved in decontamination should demonstrate current immunisation for hepatitis B and, subject to local policy, tetanus. Staff must be informed of the benefits (for example protection against serious illness, protection against spreading illness) and drawbacks (for example reactions to the vaccine) of vaccination.

Note

Vaccination is considered additional to, and not a substitute for, other control measures.

- t. The effective cleaning of handpieces in accordance with manufacturers' guidance. Dedicated cleaning equipment is available and may be of value. However, validation in this area is difficult, and the advice of manufacturers/suppliers should be sought.
- u. Separate wash-hand basins for use by staff conducting decontamination should be provided.
- v. Washing and rinsing of instruments can be achieved by:
- Two dedicated sinks with a separate or shared water supply.
 - One sink with a removable bowl, which can be contained within the sink that can accommodate the instruments for rinsing. This is the least preferred option as it requires lifting and moving bowls of contaminated water with associated spillage risks. The practice should have clear processes and protocols in place to ensure that the removable bowl is not used for the washing of instruments.

These sinks should not be used for hand-washing.

Essential infection control policies and procedures

- 2.5 This guidance is primarily focused on medical devices and instruments used in dentistry. However, local policies must be broad-based and consider a comprehensive view of hygiene and cleanliness across all aspects of dental practice and associated facilities.
- 2.6 All dental practices should have an infection control policy together with guidelines and procedures that contain the following information:
- a written policy with regard to minimising the risk of blood-borne virus transmission, with particular attention to the possibility of sharps injuries. The policy should include arrangements for an occupational health examination of all staff thought to be at risk of hepatitis B. (This is related to risk reduction in blood-borne virus transmission and general infection.) Confidential records of all such examinations should be maintained. In addition, a record of all sharps injuries must be maintained in accordance with current health and safety legislation. Further detail can be found in the Green Book (<http://immunisation.dh.gov.uk/category/the-green-book>);
 - a policy on decontamination and storage of dental instruments (decontamination guidelines);
 - procedures for cleaning, disinfection and sterilization of dental instruments. This should outline the approach used locally in sufficient detail as to allow the ready identification of areas and equipment used;
 - a policy for the management and disposal of clinical waste (waste disposal policy) (for further details see Health Technical Memorandum 07-01);
 - a policy for hand hygiene (see Appendix 1);
 - a policy for decontamination of new reusable instruments (see [paragraphs 10.24–10.30](#));
 - local policies and procedures for the use of personal protective equipment (PPE);
 - procedures for the management of dental instruments and associated equipment in the context of infection control;
 - the recommended disinfectants to be used within the practice, their application, storage and disposal (disinfectant guidelines);

- spillage procedure as part of local COSHH arrangements;
- local policies and procedures for environmental cleaning and maintenance. This should include, at a minimum, the methods used, the frequency of each procedure and appropriate record-keeping practices.

- 2.7 Dental practices may consult with local infection control specialist advisers in order to obtain support in the writing of local policies, within the framework provided here, and the design of local procedures together with guidance implementation planning (see also [Chapter 6](#), which gives general guidance on cleaning and disinfection protocols within the practice).

Movement of instruments to and from adjacent decontamination areas

- 2.8 The object of the measures outlined below is to reduce the risk of cross-contamination between instruments.
- 2.9 The practice should have safe procedures for the transfer of contaminated items from the treatment to the decontamination area.
- 2.10 Sterilized instruments and single-use instruments should be clearly separated from those that have been used and are awaiting decontamination.
- 2.11 A separate sterilized instrument tray should be used for each patient. These trays should be of a suitable size to enable them to be placed in the sterilizer. Alternatively, single-use instrument trays may be used, provided these have been stored in a clean and dry environment.
- 2.12 Instruments for decontamination should be transferred as soon as possible after use to the decontamination area in order to avoid the risk of drying. Prompt decontamination is appropriate. Potable water immersion or the use of commercial gels/sprays may be considered if a delay in reprocessing is unavoidable.

Segregating instruments

- 2.13 Prior to cleaning, reusable instruments to be cleaned should be segregated from items for disposal.
- 2.14 A single-use device should only be used during a single treatment episode and then disposed of. It is not intended to be reprocessed and used again – even on the same patient at a later session.

- 2.15 The re-use of a single-use device has implications under the Medical Devices Regulations. Anyone who reprocesses or re-uses a device CE-marked for use on a single occasion bears the responsibilities normally carried by the manufacturer for the safety and effectiveness of the instrument.
- 2.16 Shown below is the symbol that identifies single-use items. This will appear on packaging but might not be present on individual items. If in doubt, further advice should be sought from the manufacturer.



- 2.17 Where instruments are difficult to clean, consideration should be given to replacing them with single-use instruments where possible. In dentistry this will include, but is not limited to, instruments such as matrix bands, saliva ejectors, aspirator tips and three-in-one tips.
- 2.18 Where endodontic reamers and files are designated reusable, they should be treated as single patient use or single use – regardless of the manufacturer’s designation – to reduce the risk of prion transmission. Practices must have effective procedures in place to exclude errors in identifying the instrument(s) and associating them with the correct patient.
- 2.19 Care needs to be exercised in the cleaning of re-usable endodontic reamers and files. Where automated washer–disinfectors are used, the risk of cross-contamination to other instruments would be very low, in view of the dilution factors. These instruments do not need to be processed on a separate cycle. However, owing to the variability in dilution during manual washing, the files/reamers should be washed separately from other instruments.

Quality assurance system and audit

- 2.20 Dental practices are required to establish and operate a quality assurance system that covers the use of effective measures of decontamination and infection control. This may best be demonstrated by undertaking audits and assessments of their infection control and decontamination practices. These audits should be filed for inspection as part of their risk management system.
- 2.21 Compliance with this Health Technical Memorandum will be seen as indicative of the presence of valid quality assurance systems. At a minimum, practices should audit their decontamination processes every six months, with an appropriate review dependent on audit outcomes.

Note

The Infection Prevention Society/DH audit tool parallels the guidance provided in this document. In addition, a number of other safety-related topics are included in the tool. See [paragraph 1.7](#).

- 2.22 It is important that the audits are made available to regulatory bodies for inspection when required.
- 2.23 Audit documents should be stored for at least two years. They should not be removed from the premises or destroyed.

Taking instruments to other locations

- 2.24 The practice should have safe procedures for the transfer of contaminated items from the treatment area to the decontamination facility.
- 2.25 Transport containers should be such as to protect both the product during transit and the handler from inadvertent contamination, and therefore should be:
- leak-proof;
 - easy to clean;
 - rigid, to contain instruments, preventing them becoming a sharps hazard to anyone handling the goods and to protect them against accidental damage;
 - capable of being closed securely;
 - robust enough to prevent instruments being damaged in transit.

- 2.26 Containers for transport of instruments for decontamination and of sterilized instruments should be clearly marked as for each function and should not be used interchangeably
- 2.27 Containers for transporting instruments for decontamination should be kept visibly clean. When transporting sterilized instruments, to avoid recontamination it is preferable that they are wrapped or separated from direct contact with their container on a tray that itself has been sterilized. If this is not feasible, sterilized instruments may be transported in a container that has been disinfected with a single-use disinfectant wipe and allowed to dry, but chemical disinfection is a lower quality assurance process than sterilization
- 2.28 Where contaminated instruments are to be transported outside of the healthcare premises on a public highway, those responsible for such transportation should refer to the requirements of the Carriage of Dangerous Goods and Use of Transportable Pressure Equipment Regulations 2007 and the Health and Safety at Work etc Act 1974.
- 2.29 A protocol for transportation that ensures the segregation of contaminated product from clean/sterilized instruments should be followed.
- 2.30 Contaminated instruments will be regarded as low biohazard materials and must be part of a noted consignment. This means recording details of the group of items transported (that is, dental instruments), the time of dispatch and the intended recipient. Records should be such as to allow each movement to be traced and audited if necessary. The note should be positioned prominently within any vehicle used for transportation and should carry a contact telephone number.
- 2.31 Where instruments travel in a vehicle with a dentist or other expert person, record-keeping may be simplified to cover the date and vehicle used only. This rule is applicable to, for example, school and domiciliary visits.

Best practice

Progress towards achieving **best practice** should include the following:

- Install a validated washer-disinfector of adequate capacity to remove the need for manual washing.
- Improve separation of decontamination processes from other activities and enhance the distinction between clean and dirty workflows.
- Provide suitable storage for instruments, which reduces exposure to contamination. **Best practice** will include the development of a local quality system focused on safe and storage of instruments. This will ensure that instrument storage is well protected in the appropriate clean room against the possibility of exposure of stored instruments to contaminated aerosols. In addition the management approach will ensure that commonly-used instruments are dealt with on a first-in first-out principle and less frequently used instruments are stored with clear identification and reprocessed if not used within the designated storage periods.

3 Cleaning instruments

Guidance on the installation, validation, maintenance and testing of ultrasonic cleaners and washer-disinfectors can be found in [Section 3](#).

Introduction

- 3.1 The principal methods of cleaning reusable dental instruments currently available are: cleaning using a washer-disinfector; manual combined with ultrasonic cleaning; manual.
- 3.2 Effective cleaning of instruments is an essential prerequisite before sterilization and will reduce the risk of transmission of infectious agents. Wherever possible, cleaning should be undertaken using an automated and validated washer-disinfector in preference to manual cleaning, as a washer-disinfector includes a disinfection stage that renders instruments safe for handling and inspection.
- 3.3 Manual cleaning, governed by an appropriate protocol, is acceptable within the essential-quality-requirements framework. Within the best-practice framework, however, manual cleaning should be considered only where the manufacturer specifies that the device is not compatible with automated processes (including ultrasonic cleaning) or when the washer-disinfector is temporarily unavailable (for example for repair or validation). Exceptionally, where local experience indicates that pre-washing may be helpful (for example in the removal of tenacious dental materials), such action may be appropriate before automated cleaning.
- 3.4 New instruments should be cleaned and sterilized before using for the first time, unless supplied as sterile.
- 3.5 Instruments cleaned as soon as possible after use may be more easily cleaned than those left for a number of hours before reprocessing. Where this is not possible, water immersion or the use of a foam spray or gel intended to maintain a moist or humid environment are thought useful in aiding subsequent decontamination. Long periods of wet storage should, however, be avoided.

- 3.6 When working with substances that can harden on instruments (for example cements), the instruments should be cleaned immediately. Instruments that cannot be cleaned should be discarded.
- 3.7 Where recommended by the manufacturer, instruments and equipment that consist of more than one component should be dismantled to allow each part to be adequately cleaned. Members of the dental team should be appropriately trained to ensure competence in dismantling, cleaning, sterilizing and reassembling of instruments. Amalgam carriers are an example of instrumentation requiring this approach.

General requirements for cleaning methods

- 3.8 Where possible, refer to manufacturers' instructions relating to instruments, dental equipment, cleaning devices and cleaning solutions.
- 3.9 Whenever possible, cleaning should be undertaken using an automated and validated process in preference to manual cleaning. Manual cleaning should be considered where manufacturers' instructions specify that the device is not compatible with automated processes.
- 3.10 Ensure that instruments can be cleaned using a method available to the practice.
- 3.11 Validation is the means by which an entire process is verified, tested and documented, with the ability to be consistently reproducible. Ensure that ultrasonic and washer-disinfector cleaning procedures used in the practice are validated. This is to demonstrate that all instruments and equipment cleaned by these methods are reliably and consistently cleaned using predetermined and reproducible conditions.
- 3.12 Technical details for validation standards and procedures are provided in [Section 3](#). The assistance of decontamination specialists will be necessary from time to time in order to ensure that equipment and procedures remain valid in engineering terms.

Automated cleaning: washer-disinfectors

3.13 The fitting and plumbing of washer-disinfectors must comply with the requirements of the Water Supply (Water Fittings) Regulations 1999. Further details can be found on the WRAS website (<http://www.wras.co.uk>). Each stage of the decontamination process should contribute to the reduction of bioburden on the device being reprocessed. Using a washer-disinfector is the preferred method for cleaning dental instruments because it offers the best option for the control and reproducibility of cleaning; in addition, the cleaning process can be validated under European Norms (ENs).

3.14 Washer-disinfectors are used to carry out the processes of cleaning and disinfection consecutively in an automated cycle. A typical washer-disinfector cycle for instruments includes the following five stages:

- **Flush** – removes “difficult” gross contamination, including blood, tissue debris, bone fragments and other fluid and solid debris. Latest standards indicate that a water temperature of less than 45°C is used to prevent protein coagulation and fixing of soil to the instrument.
- **Wash** – removes any remaining soil. Mechanical and chemical processes loosen and break up contamination adhering to the instrument surface. Detergents used in this process must be specified by the manufacturer as suitable for use in a washer-disinfector and compatible with the quality of water used. Detergents should also be compatible with the instruments being processed to avoid instrument degradation including discoloration, staining, corrosion and pitting.
- **Rinse** – removes detergent used during the cleaning process. This stage can contain several sub-stages. The quality of water to be used for this stage is an important consideration in terms of ensuring a clean unmarked product after sterilization. Advice should be taken from manufacturers with respect to the compatibility of the hardness or quality of the water supply with the equipment and detergents used.

Note

Some systems with a water capacity and delivery rate specially suited to use in this and other dental applications are available. The supply arrangements will frequently include a comprehensive package such that water is supplied as a service.

- **Thermal disinfection** – the temperature of the load is raised and held at the pre-set disinfection temperature for the required disinfection holding time: for example, 80°C for 10 minutes; or 90°C for 1 minute.
- **Drying** – Purges the load and chamber with heated air to remove residual moisture.

Using a washer-disinfector

- 3.15 For details of all operational aspects of using a washer-disinfector, follow the manufacturer’s instructions. This will include details of both the water quality/type to be used and directions on the detergents and/or disinfectants recommended for use with the device. These instructions form part of the European norm (EN) requirements for CE (Conformité Européenne) marking and are considered to be part of the regulated product.
- 3.16 Ensure that staff are trained in the correct operation of a washer-disinfector, including how to perform daily tests and housekeeping tasks. Records of training and the achievements of staff should be maintained (see [Section 3](#)).
- 3.17 It is crucial to load a washer-disinfector correctly, as incorrectly loaded instruments will not be cleaned effectively. Therefore, follow an instrument-loading procedure that has been shown to achieve effective cleaning in the washer-disinfector used in the practice. To do this:
- do not overload instrument carriers or overlap instruments;
 - open instrument hinges and joints fully;
 - attach instruments that require irrigation to the irrigation system correctly, ensuring filters are in place if required (for example for handpieces, if specified by the manufacturer).
- 3.18 After cleaning, inspect instruments for cleanliness and check for any wear or damage before sterilization. (The use of a simple magnifying device with task lighting will improve the value

of this part of the process.) The satisfactory completion of this step means that these instruments may be clearly designated as ready for sterilization.

Records

3.19 Washer-disinfector logbooks and records should be kept by the designated “user” – an identified member of the practice staff. Cycle parameters should be recorded together with details of routine testing and maintenance of the equipment used. The use of automated data-loggers or interfaced small computer-based recording systems is acceptable, provided the records are kept securely and replicated. It is recommended that records be maintained for not less than two years.

Considerations for cleaning handpieces

3.20 Check with the handpiece manufacturer that a washer-disinfector can be used to clean the handpieces.

3.21 Certain types of washer-disinfector can be adapted to clean handpieces, and these can be validated independently as being effective.

3.22 Where a handpiece manufacturer does not recommend a washer-disinfector for cleaning the handpiece, use of a dedicated handpiece-cleaning machine may be considered. This uses a pressurised system to clean and lubricate handpieces. However, unlike a washer-disinfector, it does not disinfect.

3.23 Always consult the washer-disinfector manufacturer for operating details (for example whether filters are required) and running costs before purchase.

3.24 Washer-disinfectors might remove all lubricants during the cleaning cycle; therefore, handpieces might require further lubrication after cleaning. Follow the handpiece manufacturer’s recommendations for lubrication (see also [paragraphs 3.55–3.57](#) and [Chapter 18](#) in Section 3).



Using a washer-disinfector is the preferred method for cleaning dental instruments because it offers the best option for the control and reproducibility of cleaning

Note

1. Some washer-disinfectors that have a handpiece irrigation system require that a special filter be fitted to protect the internal mechanism of the handpiece from extraneous debris during the operating cycle. These filters need to be replaced at regular intervals in accordance with the manufacturer's instructions.
2. There are machines that both clean and sterilize dental handpieces. At present it is not possible to validate the cleaning cycle of these devices using accepted criteria. However, due to the use of a vacuum sterilization cycle (Type S) there is an advantage of this process over using a Type N sterilizer.

Automated cleaning: ultrasonic cleaning

- 3.25 Evidence on the effectiveness of ultrasonic cleaning gives support to its use in dentistry. However, it is important to ensure that the water/fluid is maintained, cleaned and changed at suitable intervals (see [paragraph 3.30k](#)). The bath should also be kept free of dirt released in the cleaning process. Good maintenance is also essential. The appearance of instruments following ultrasonic cleaning should be checked to ensure that the process is operating effectively (see also [Section 3](#)).
- 3.26 Ultrasonic cleaning in a well-maintained machine enhances removal of debris. Thus, although a washer-disinfector is preferred and should be incorporated into new plans or upgrades, an ultrasonic cleaner can be used as a cleaning method – including being used as an extra cleaning stage prior to an automated washer-disinfector process. This may be particularly helpful for instruments with hinges and/or intricate parts.
- 3.27 To enable consistent cleaning of instruments, follow the manufacturer's operating instructions and ensure that all staff use a specified and documented operating procedure. Details on validating ultrasonic cleaners are supplied in [Section 3](#).
- 3.28 The use of ultrasonic cleaners to clean dental handpieces should not be undertaken without confirmation from the manufacturer that the devices are compatible.
- 3.29 The ultrasonic cleaner should be tested according to the manufacturer's instructions or, in the absence of these, quarterly (see Section 3, [Chapter 14](#)).
- ### Ultrasonic cleaning procedure
- 3.30 The following procedures should be followed:
- a. Instruments should be briefly immersed in cold water (with detergent) to remove some of the blood and other visible soil before ultrasonic cleaning. Care should be taken to minimise aerosol production in this process and to safeguard against inoculation injury. The use of a purpose-designed container with sealing lid is recommended.
 - b. Follow the manufacturer's recommendations for the safe operating procedure of the ultrasonic cleaner and follow the points outlined below regarding loading and unloading the cleaner.
 - c. Ensure that joints or hinges are opened fully and **instruments that need taking apart are fully disassembled before they are immersed in the solution**.
 - d. Place instruments in a suspended basket and fully immerse in the cleaning solution, ensuring that all surfaces are in contact with the solution. The solution should be made up in accordance with the manufacturer's instructions.
 - e. Do not overload the basket or overlap instruments, because this results in poor cleaning and can cause wear to the instruments.
 - f. Do not place instruments on the floor of the ultrasonic cleaner, because this results in poor cleaning and excessive instrument movement, which can damage the instruments.
 - g. To avoid damage to delicate instruments, a modified basket or tray system might also be necessary depending on operational requirements.
 - h. Set the timer to the correct setting as per the ultrasonic cleaner manufacturer's instructions. Close the lid and do not open until the cycle is complete.
 - j. After the cycle is complete, drain the basket of instruments before rinsing.
 - k. Change the solution when it becomes heavily contaminated or otherwise at the end of every clinical session, because the build-up of debris will reduce the effectiveness of cleaning. Ensure

that staff are aware of the need to assess when a change of solution is necessary as advised in the operational requirements.

- m. After ultrasonic cleaning, rinse and inspect instruments for cleanliness, and where possible check for any wear or damage before sterilization.
- 3.31 Instruments cleaned in an ultrasonic cleaner (or by hand) should be rinsed thoroughly to remove residual soil and detergents. A dedicated sink or bowl (separate from the one used for the original wash) should be used, and the instruments immersed in satisfactory potable water or, where this is not available, in RO or distilled water. Wash-hand basins should not be used. (This step may be omitted if the local policy and procedure involves the use of a washer-disinfector as the next stage in the decontamination process.)

Note

Hard-water contamination of wet instruments, which then go on to sterilization, can compromise the proper function of a small steam sterilizer. Advice should be sought from the manufacturers. When potable water is used, a water softener device may be needed (see [paragraphs 17.8–17.10](#)).

- 3.32 Instruments should be sterilized as soon as possible after cleaning to avoid air-drying (which can result in corrosion and/or microbial growth). For instruments processed in a vacuum sterilizer, before being wrapped, instruments should be dried using a disposable non-linting cloth.

Manual cleaning

- 3.33 In principle, manual cleaning is the simplest method to set up, but it is hard to validate because it is difficult to ensure that it is carried out effectively on each occasion.
- 3.34 Compared with other cleaning methods, manual cleaning presents a greater risk of inoculation injury to staff. However, despite the limitations of manual cleaning, it is important for each practice to have the facilities, documented procedures and trained staff to carry out manual cleaning as a backup for when other methods are not appropriate.
- 3.35 For dental services that are working to the **best practice** requirements outlined in this document, manual cleaning (acceptable under the **essential quality requirements**) should only be used for equipment that cannot be cleaned by automated methods.
- 3.36 This method should have systems in place to avoid recontamination of clean instruments.
- 3.37 An effective system for manual cleaning should be put in place, as outlined in [Section 3](#), and all staff should follow an agreed written procedure. A visual inspection for cleanliness, wear and damage should be carried out.
- 3.38 Consider routinely using an automated method (for example a washer-disinfector). Aim to phase in instruments that can be cleaned in a washer-disinfector.

Avoiding instrument damage

- 3.39 Most dental instruments are made of high-quality materials designed to minimise corrosion if reprocessed correctly. The corrosion resistance is based on their alloy composition and structure, which forms a protective passivation layer on the surface. The ability of the instruments to resist corrosion depends on the quality and thickness of this layer.
- 3.40 It is important to avoid damage to the passivation layer during cleaning. Accordingly, methods such as the use of wire brushes, which may give rise to surface abrasion, should be avoided.
- 3.41 Any instruments that have rust spots should be removed.

Cleaning procedure summary

- 3.42 Effective cleaning of dental instruments before sterilization is of the utmost importance to reduce the risk of transmission of infectious agents.
- 3.43 Research suggests that instruments cleaned as soon as possible after use are more easily cleaned than those left for a number of hours before reprocessing.
- 3.44 Instruments should be transferred from the point of use to the decontamination areas as soon as is practical to ensure that processing takes place as soon as possible after use. Evidence indicates that keeping instruments moist after use and prior to decontamination improves protein removal and overall decontamination outcomes.
- 3.45 It should be noted that certain solutions are corrosive to stainless steel instruments and will cause pitting and then rusting if allowed to remain on instruments for any length of time. Dental

professionals should consult with the suppliers/manufacturers of decontamination agents to ensure that the products used are appropriate and unlikely to cause significant long-term corrosion (refer to COSHH for further advice).

- 3.46 Always check packaging for the single-use symbol before use, and note that it might be difficult to see (see also [paragraphs 2.13–2.19](#)).

Rinsing of instruments after cleaning and or disinfection

- 3.47 Instruments cleaned in an ultrasonic cleaner (or in addition by hand) should be rinsed thoroughly in a dedicated sink or bowl (separate from the one used for the original wash) using satisfactory potable water, or freshly prepared RO water or distilled water in order to remove residual soil and detergents with minimum risk of salt deposition.

Note

This step may be omitted if the local policy and procedure involves the use of a washer-disinfector as the next stage in the decontamination process.

- 3.48 Instruments should be sterilized as soon as possible after cleaning to avoid air-drying (which can result in corrosion and/or microbial growth). However, where instruments are to be wrapped prior to vacuum sterilization, the instruments should be dried.

Inspection and care of instruments before sterilizing

- 3.49 All instruments that have been through any cleaning procedure, including processing by a washer-disinfector, should be inspected to ensure they are clean, functional and in good condition.
- 3.50 Any instruments that are blunt, bent or damaged or show any signs of pitting or other corrosion should be discarded. An illuminated magnifier is recommended because it makes it much easier to see residual contamination, debris or damage.
- 3.51 Dental staff should ensure that: there is free movement of all parts and that joints do not stick; the edges of clamping instruments meet with no

overlap and that teeth mesh together; scissor edges meet to the tip and move freely across each other with no overlap or burrs (rough edges); all screws on jointed instruments are tight and have not become loose during use.

- 3.52 Instruments should be inspected for any visible soiling such as blood or dental materials. It is especially important to check joints, hinges or the serrated surfaces of jaws, which are difficult to clean. If there is any residual contamination, the instrument should be rejected and should undergo another cycle of the cleaning process.
- 3.53 Occasional use of a lubricant may be required where hinged instruments are found to be stiff. A non-oil-based lubricant should be used to avoid it interfering (that is, preventing the steam coming into contact with the instrument surface) with the sterilization process.
- 3.54 Instruments may become damaged during use or suffer from general wear and tear over their lifespan. If devices are found to be faulty or damaged during inspection and function-testing, or if users identify that they are faulty, they should be taken out of use and either repaired or replaced. Instruments for repair should be decontaminated, labelled to identify they have been through the decontamination process, and then returned to either the manufacturer or a reputable repair company.

Handpiece care

- 3.55 Handpieces should be lubricated according to the manufacturer's instructions. Those that have been processed in a washer-disinfector might have had the lubricant removed and require lubrication again before going into the sterilizer.
- 3.56 A separate canister of lubricant should be used for cleaned instruments. The canisters should be labelled so that it is clear which canister is used for unclean instruments and which is used for instruments that have been cleaned in a washer-disinfector. Another canister for use with handpieces after sterilization might be required if the manufacturer recommends it.
- 3.57 Inadequate lubrication can lead to unnecessary damage to the internal mechanism.

4 Sterilization

Guidance on the installation, validation, maintenance and testing of sterilizers can be found in [Section 3](#).

- 4.1 This chapter should be read in conjunction with [Section 1](#).

Types of sterilizer

- 4.2 Saturated steam under pressure delivered at the highest temperature compatible with the product is the preferred method for the sterilization of most instruments used in the clinical setting.
- 4.3 To facilitate sterilization, load items should first be thoroughly cleaned and disinfected (where a washer-disinfector has been used). In the case of newer machines, the parameters monitored for each



Sterilization process data can be recorded by an automatic printer

cycle will be stored and/or available as a print-out to provide a short-term record. The use of automated data-loggers or interfaced small computer-based recording systems is acceptable provided the records are kept securely and backed-up. These records should be copied, as the quality of the print-out fades over time. Manual recording using a logbook is also acceptable, and in any case will be a necessity if a machine does not have any automatic print-out function (see [paragraph 4.14](#) for further details on manual recording). The record should, at minimum, document the absence of a failure warning or the temperature/pressure achieved as appropriate to the indications provided. Records are required for every sterilization cycle. It is recommended that records be maintained for not less than two years.

- 4.4 It is likely that steam sterilizers used in dental practices will have a chamber volume of less than 60 L and thus be considered to be small devices within the standards applied by national and international bodies.
- 4.5 Standards describe three types of benchtop sterilizer used within the healthcare setting:
- Type N: air removal in type N sterilizers is achieved by passive displacement with steam. They are non-vacuum sterilizers designed for non-wrapped solid instruments.
 - Type B (vacuum): type B sterilizers incorporate a vacuum stage and are designed to reprocess load types such as hollow, air-retentive and packaged loads. A number of different cycles may be provided. Each cycle should be fully validated and used in accordance with instructions provided by both the sterilizer manufacturer and the instrument manufacturer(s).
 - Type S: these sterilizers are specially designed to reprocess specific load types. The manufacturer of the sterilizer will define exactly which load, or instrument, types are compatible. These



Sterilizer with automatic printer

sterilizers should be used strictly in accordance with these instructions.

Types B and N are most frequently used in dental practices.

- 4.6 In each case, practice staff should consult with the manufacturer/supplier of the sterilizer(s) to ascertain the status of the machine in respect of validation/verification and the recording of parameters achieved during sterilization cycles.

Dental handpieces

- 4.7 Practices can seek the advice on the decontamination of handpieces from the handpiece manufacturer. Dental handpieces are constructed with a number of features that are difficult to clean and sterilize. The use of a validated washer-disinfector may be successful provided that the

handpiece and washer-disinfector are compatible. Where this is established, sterilization using a type B or type S sterilizer is likely to be useful, although it should be accepted that it is unlikely that sterility will be achieved – whatever sterilizer is used – due to the presence of lubricating materials. The information above should be used by practices to make an informed decision on the choice of sterilizer (Type B, S or N).

- 4.8 If no validated and compatible washer-disinfector is available, steam sterilization will generate a reduction in contamination. Accordingly, progress towards best practice may be seen as a further risk reduction measure in this context.

Benchtop sterilizers

4.9 Benchtop sterilizers should be operated to ensure that:

- they are compliant with the safety requirements stated in this guidance and in the manufacturer's notes;
- they are installed, commissioned, validated and maintained appropriately in compliance with the manufacturer's instructions (see [Section 3](#));
- they are operated in accordance with the equipment manufacturer's instructions.

Pre-wrap instruments only where this is recommended by the manufacturer and where the sterilizer is vacuum-assisted. The sterilizer should be validated for the intended load and is likely to be of type B or S. **The use of a type N sterilizer is not appropriate for wrapped instruments.**

4.10 All steam sterilizers are subject to the Pressure Systems Safety Regulations 2000 and must be examined periodically by a Competent Person (Pressure Vessels).

Use and testing of benchtop sterilizers

4.11 To ensure the safety of this device, the following points should be adhered to:

1. Each sterilizer will have a reservoir chamber from which the water is delivered for steam generation. This should be filled, at least daily, using distilled or RO water. However, more frequent draining and refilling offers quality advantages in terms of the appearance and suitability of the finished instruments. At the end of the working day, the device should then be cleaned, dried, and left empty with the door kept open. For single-shot types, which do not store water between cycles of use, these rules still apply in terms of the water quality to be used.
2. Validation is necessary to demonstrate that the physical conditions required for sterilization (temperature, pressure, time) are achieved. Consultation with appropriately qualified engineers will be necessary. A Competent Person (Decontamination) or service engineer will be able to ensure that validation is achieved and that the instrumentation used for parametric release is functioning and calibrated appropriately. The Competent Person (Decontamination) or service engineer will be

needed to validate or revalidate the equipment (see [Section 3](#)).

Parametric release is defined as the release of a batch of sterilized items based on data from the sterilization process. All parameters within the process have to be met before the batch can be released for use.

3. Testing is an integral part of ensuring that a benchtop sterilizer consistently performs to operating parameters set during the machine's commissioning. Failure to carry out routine periodic tests and maintenance tasks could compromise safety and have legal and insurance-related implications for the Registered Manager (see [paragraph 9.3](#)).
4. A schedule for periodic testing should therefore be planned and performed in accordance with [Section 3](#). The schedule should provide details of daily, quarterly and yearly testing or be in accordance with manufacturers' guidelines. Each sterilizer should have a logbook (file) in which details of the following are recorded:
 - maintenance;
 - validation;
 - faults;
 - modifications;
 - routine tests (see Appendix 2).

4.12 Health Service Circular (HSC) 1999/053 and the subsequent 'Records management: code of practice parts 1 and 2' (April 2006) provide guidance on the length of time for which records should be retained. Reference should be made to the time period of legal rights of patients, and all relevant documentation should be retained for the practice to meet any request within these rights. The code requires that these records be maintained for not less than two years, although longer periods may be applicable subject to local policy-making.

4.13 The logbook should contain all information pertaining to the lifecycle of the equipment (from purchasing through to disposal).

- 4.14 If the sterilizer has an automatic printer, the print-out should be retained or copied to a permanent record. If the sterilizer does not have a printer, the user will have to manually record the following information in the process log:
- date;
 - satisfactory completion of the cycle (absence of failure light);

- temperature/pressure achieved;
- signature of the operator.

Daily testing and housekeeping tasks

- 4.15 Some benchtop sterilizers require a warm-up cycle before instruments can be processed. The manufacturer's instruction manual should be consulted to find out whether this is the case.
- 4.16 The daily tests should be performed by the operator or user and will normally consist of:
- a steam penetration test – Helix or Bowie-Dick tests (vacuum sterilizers only);
 - an automatic control test (all benchtop sterilizers) in line with manufacturers' instructions;
 - a record of the temperature and pressure achieved at the daily test, to ensure this is satisfactory before the autoclave is used for sterilizing instruments.
- 4.17 These outcomes should be recorded in the logbook together with the date and signature of the operator.
- 4.18 The tests may be carried out at the same time.

4.19 The manufacturer's advice should be sought on whether the daily tests can be carried out while instruments are being reprocessed.

4.20 Before carrying out the daily tests, the user should:

- clean the rubber door seal with a clean, damp, non-linting cloth;
- check the chamber and shelves for cleanliness and debris;
- fill the reservoir with distilled water or RO water;
- turn the power source on.

4.21 If the sterilizer fails to meet any of the test requirements, it should be withdrawn from service and advice should be sought from the manufacturer and/or maintenance contractor. Any instruments processed in an unsuccessful cycle should not be used.

Packaging and related decontamination strategy

4.22 There are three combinations of steam-sterilization and instrument-wrapping strategies that can be used within dental practices:

- Instruments should be cleaned and dried before being wrapped with purpose-designed materials



The outcomes of daily tests should be recorded in the logbook

compatible with the sterilization process. These packaging materials should either conform to BS EN ISO 11607-1 or, for Type S sterilizers, be validated as suitable by the sterilizer manufacturer. These instruments are suitable for storage for up to 12 months in their original packaging as long as their packaging is intact. Practices will need to have systems in place to be able to demonstrate that the 12-month storage time is not being exceeded.

- b. With a displacement steam sterilizer (type N), the instruments will not be wrapped prior to sterilization. Immediately after removal from the sterilizer, instruments should be aseptically wrapped using suitable sealed view packs. This could be achieved by the use of forceps, clean gloves or any other appropriate process. In addition, the entire tray may be placed within a sealed pack for storage purposes. In both of these instances, storage for up to 12 months is recommended. Practices will need to be able to demonstrate that this storage time is not being exceeded.
- c. Unwrapped following processing in a displacement steam sterilizer (type N) (see [paragraph 2.4k\(ii\) and \(iii\)](#)).

4.23 In all three cases, the instruments should be dried using disposable non-linting cloths and be appropriately handled. It is essential to ensure that the cloth is adequately dry and free from contamination. Accordingly, the cloth should be disposed of after each sterilizer load.

4.24 Regardless of the packaging used, where instruments are to be stored, the date by which they should be used or by which they are subject to a further decontamination cycle should be clearly indicated on the packaging.

Storage of sterilized instruments/ devices

4.25 Regardless of the approach described above, it is essential that stored instruments are protected against the possibility of recontamination by pathogens. A barrier(s) should therefore be maintained between the instruments and the general practice environment. This may be achieved by ensuring that instruments are stored in an environment where they are protected against excessive heat and where conditions remain dry.

Note

BS EN ISO 11607-1:2006 Annex A provides a useful summary of “sterile barrier systems”. In practice, these are sealable trays or wrappings, which may be of value in dental practices. In summary, the systems referred to are:

- a. Flexible peel pouch (sealed view pack). This is typically supplied sealed on three sides with the remaining side open for the insertion of dental instruments. This packaging, subject to manufacturers’ advice, may be used to post-wrap instruments after steam sterilization in order to protect against recontamination.
- b. Pre-formed rigid tray with die-cut lid. The lid may be permeable or impermeable. These trays are potentially suitable for use with displacement or vacuum sterilizers. Subject to manufacturers’ instructions, the trays may be used to contain dental instruments during the sterilization process and in subsequent storage.
- c. Sterilization bag. This is constructed from porous medical paper and sealed before sterilization of the contents. The bag is essentially designed for use with vacuum sterilizers.
- d. Header bag. This is manufactured as a sealed bag with a heat-sealed permeable closure, which can be peeled off. This type is suitable for storage of larger items.
- e. In larger-scale operations, automated systems such as form/fill/seal (FFS) or four-side-sealing products may also be used.

The choice of system used will depend on the decontamination, sterilization and storage options chosen by the practice. The manufacturers of each of the products should be consulted on the standards applied and compatibility with the other products employed.

4.26 There should be control of storage of wrapped instruments, including the maintenance of records, clear identification of content of instrument packs, if not visible, and storage times. For commonly-used instruments, a first-in first-out principle will be helpful.

Where packs are non-transparent, it may be useful to use a label to indicate the contents.



Immediately after removal from a type N sterilizer, instruments may be wrapped using suitable sealed view-packs

4.27 As a general rule:

- The storage of reprocessed surgical instruments should ensure restraint of recontamination. This will often mean protection against aerosols and

sundry contact with other equipment. The area in which the packaging of sterilized instruments (that is, those reprocessed in a type N sterilizer) takes place should be an open bench area. It should be kept free of clutter and wiped clean by the use of detergent and and/or disinfectant wipes at sessional intervals.

- Instruments should be decontaminated in an area and in manner that enforces the flow from dirty to clean through the successive processes that comprise decontamination, such that, at no stage is an instrument recontaminated via a surface that has been contaminated at a previous decontamination stage. Dental practices must ensure that the correct processes and flows are rigorously maintained.
- Unwrapped instruments should be transported and stored in a way that minimises contamination. Appropriate personal protective equipment is required for the aseptic transfer of instruments from a type N steam sterilizer for storage (see [paragraph 6.13](#)). The worktop on which the tray or shelf of instruments is to be placed must be cleaned with a pre-prepared or



Sterilized instruments should be stored in purpose-designed storage cabinets that can be easily cleaned

single-use disinfectant wipe and allowed to dry. The decontamination area should be cleaned after each decontamination cycle is completed. The most important factor is to prevent direct or indirect contamination with patient blood and body fluid.

- Sterilized instruments should be stored in dedicated areas. If stored in areas used for clinical work, to meet **essential quality requirements**, this will require that the instruments be as far from the dental chair as reasonably practicable. **Best practice** requires that instruments not scheduled for current use with the current patients be stored in a separate environment, ideally in the clean area of the separate decontamination room.
- The storage area should be appropriately designed to prevent damage to instruments and to allow for the strict rotation of stocks.
- Cupboards should be capable of being easily cleaned and used in conjunction with sealed view-packs or covered/sealed trays.

- Products should be stored above floor level away from direct sunlight and water in a secure, dry and cool environment.
- Although air movement is often difficult to control in non-purpose-designed premises, whenever possible, airflow should be from the clean to dirty areas.

4.28 Before being used, the instruments should be checked to ensure that:

- if packed, including the use of view-packs, the packaging is intact;
- the sterilization indicator confirms the pack has been subjected to an appropriate sterilization process (if a type B sterilizer is used);
- if a covered container is used, the instruments have remained covered;
- visible contamination is absent (this is to comply with EN Standards).

4.29 As part of **essential quality requirements**, instrument storage should not exceed the limits given in [paragraph 2.4k](#).

5 Setting up a decontamination area

- 5.1 There is a clear need to maximise the separation of decontamination work from clinical activity within the constraints of space and room availability. Where instruments are reprocessed in the same room as the patient treatment area, the reprocessing area should be as far from the dental chair as practicality allows. As dental practices progress towards higher standards, removing the decontamination process from the treatment room should be a priority. For example layouts, see Figures 1–3.
- 5.2 If decontamination has to be carried out in a patient treatment room, to minimise the risks both to the patient and of cross-contamination of

instruments, appropriate controls should be in place. Uncontrolled procedures that generate the risk of exposure to aerosol dispersion or splashes (such as manual washing, the use of an ultrasonic cleaner without a sealed chamber (or lid) or the opening of decontamination equipment) should NOT take place while the patient is present.

- 5.3 Regardless of the choice of location used for the reprocessing facilities, a dirty-to-clean workflow should be maintained so that used instruments are at a lower risk of coming into contact with decontaminated instruments. This requires a well-developed routine for surface cleaning/decontamination within the facilities:

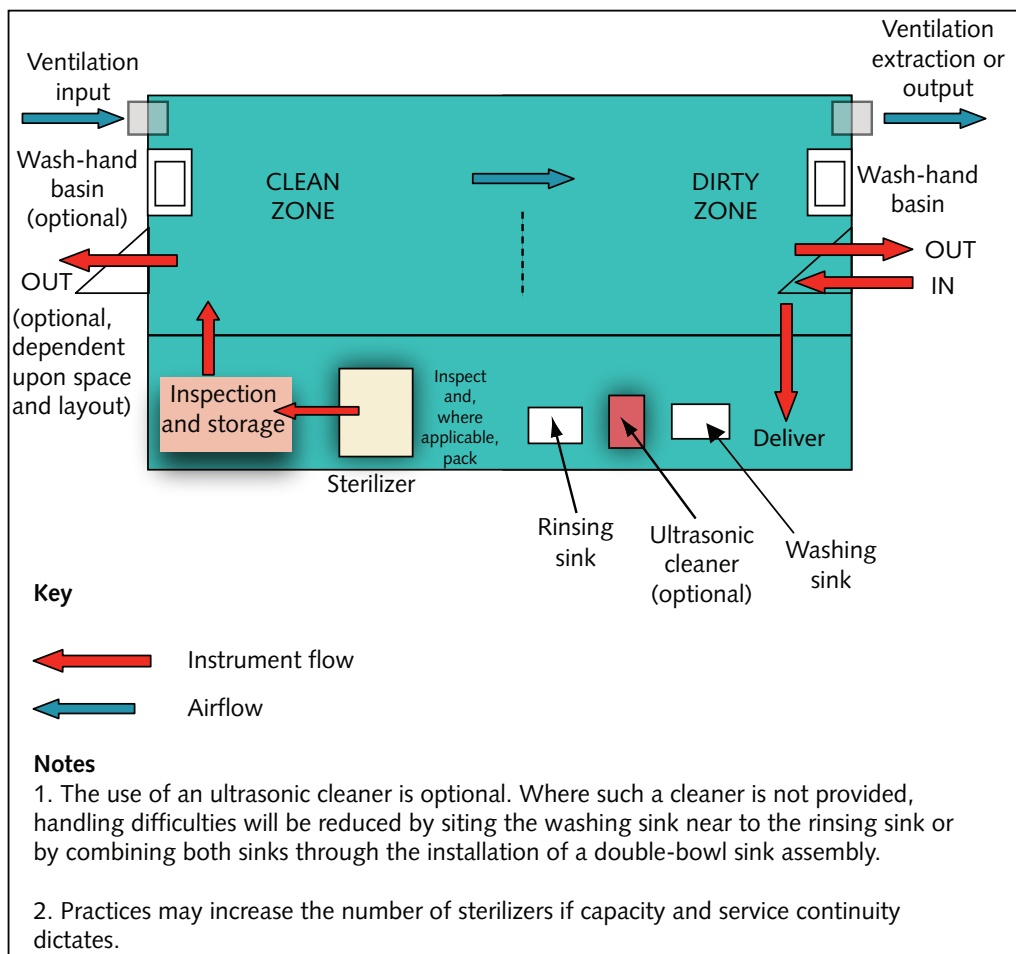

Figure 1 Example layout for essential quality requirements

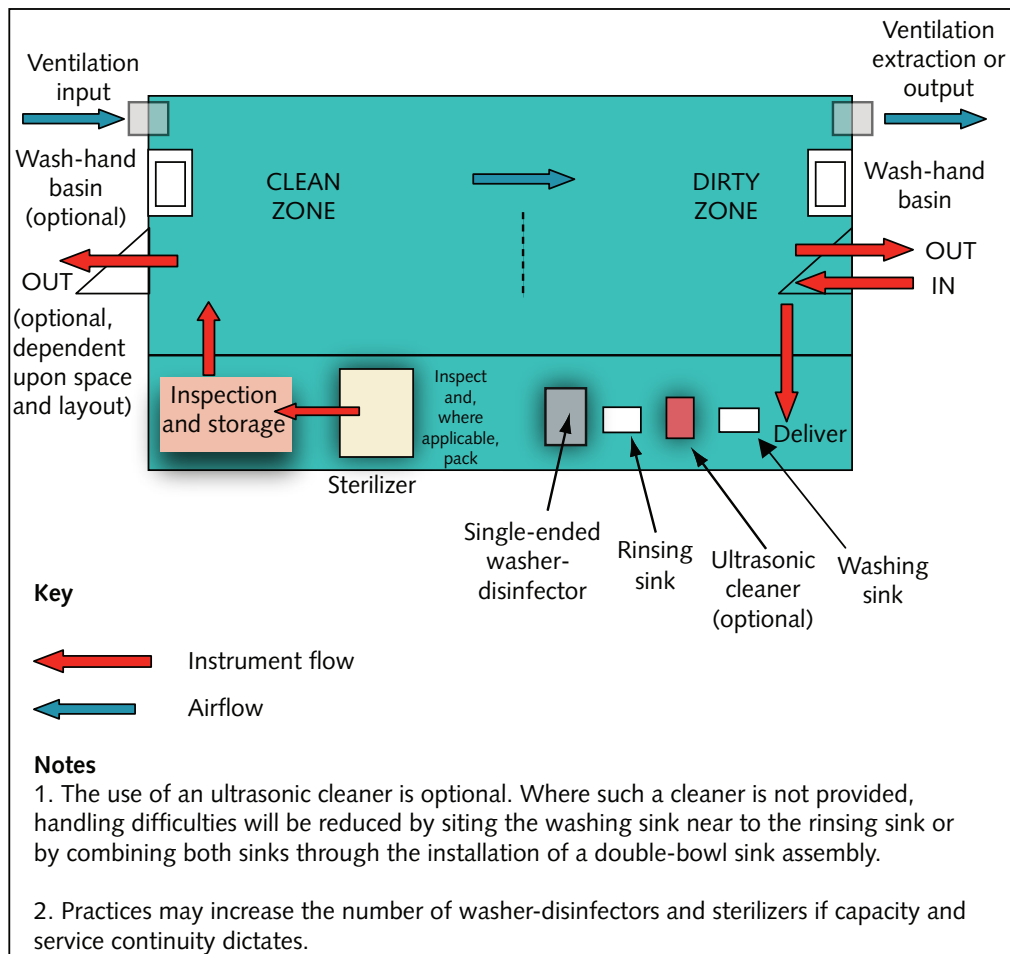

Figure 2 Example layout for single decontamination room

- the decontamination area should be wiped down carefully after each decontamination cycle is completed;
- for clinical areas, a similar wipe-clean is required after each patient procedure and before the next patient is admitted. Procedures for the wipe-down processes are described in [Chapter 6](#).
- one room for dirty activity (cleaning and preliminary inspection of instruments); and
- one room for clean activity (inspection, sterilization and wrapping instruments).

The clear intention is to reduce the risk and extent of recontamination as well as providing for a very clear operation distinction between clean and dirty.

- 5.4 Where a dedicated decontamination area has been developed, separated from the patient treatment area in another room or rooms, enhanced dirty–clean separation should be a priority in design and operation.
- 5.5 When setting up new premises or planning significant modification to existing premises, the separation of the decontamination area from the clinical area is recommended. The provision of two separate rooms is the preferred option as it provides for a higher degree of separation between dirty instruments awaiting decontamination and cleaned/sterilized instruments that are to be placed in trays, packs or containers for use:

- 5.6 Irrespective of the specific layout, a tidy working environment makes carrying out decontamination easier. Therefore, the working environment should be decluttered. The decontamination process should be carried out by ensuring that a dirty-to-clean workflow is maintained (as outlined in paragraph 5.7). This is a one-way process that can be achieved by physical segregation or temporal separation (see paragraph 5.2).

Physical segregation

- 5.7 Physical segregation within **essential quality requirements** means using different areas for different activities. A decontamination area should

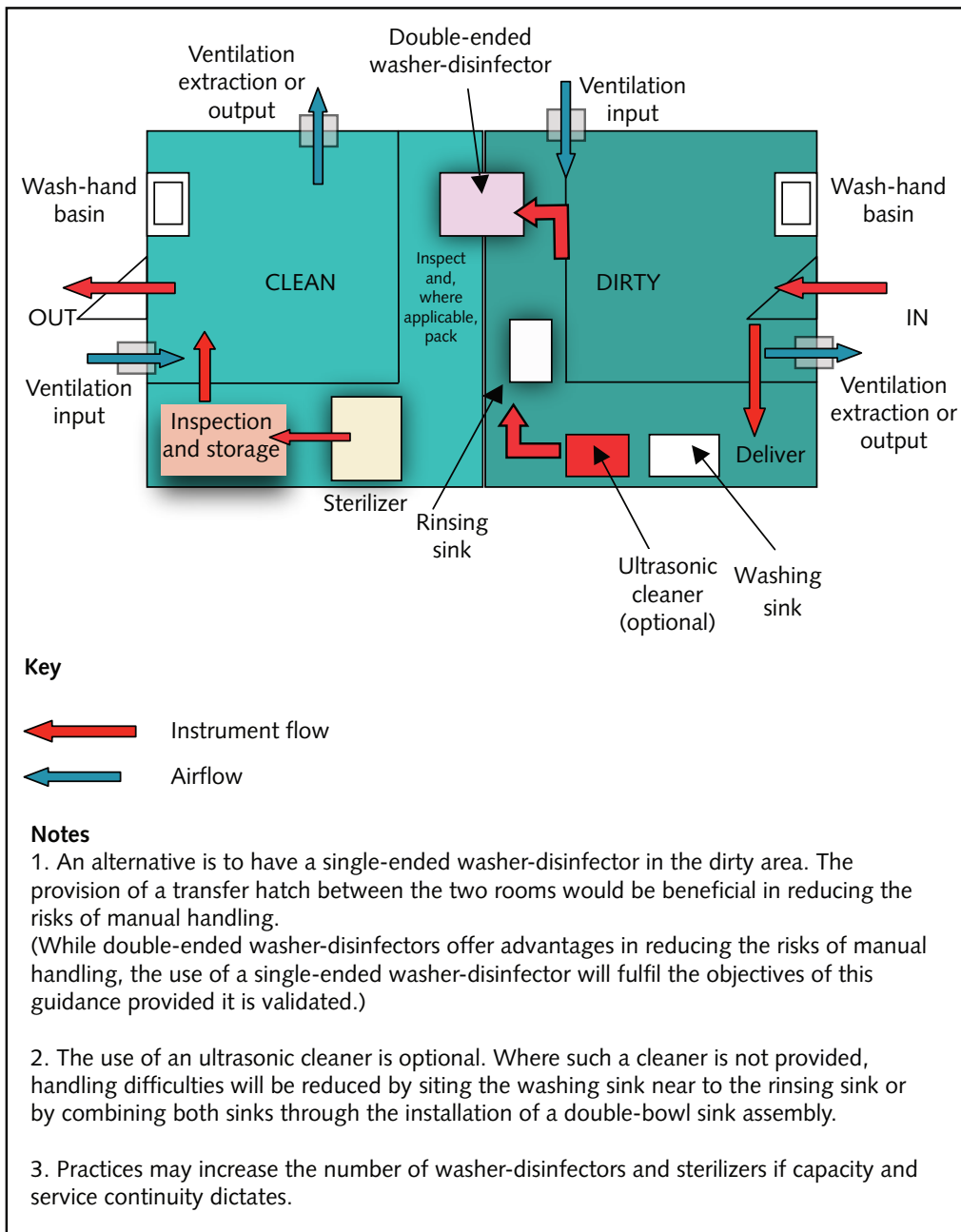

Figure 3 Example layout for two decontamination rooms

be set up which preferably comprises a single run of sealed, easily cleaned worktops. The following key design points should be observed:

- The dirty zone will be used to receive contaminated instruments. An area of benching should be clearly designated for this purpose and used for no other activity.
- The washer-disinfector (where available) and/or washing and rinsing sinks or separate bowls within a single sink unit should be installed adjacent to the receiving area. Where necessary, usually owing to space constraints, it is acceptable to use a single sink unit (incorporating two bowls with common supply and taps) for the functions described here.
- The ultrasonic cleaner (where used) should be separated from the receiving area and adjacent to the rinsing sink/bowl.
- Where a washer-disinfector is used, this may be located adjacent to an ultrasonic cleaner and/or a rinsing sink/bowl but well away from the receiving area.
- After washing and disinfection (where applicable), the instruments and devices require

inspection. A dedicated clean area of benching with good task lighting should be provided.

- The sterilizer should be situated well away from the other activities/facilities in order to promote staff safety and good decontamination practice.
- After sterilization, the sterilizer will need to be unloaded into another clean, well-lit area. Ensure that this area is kept clean – particularly just before the sterilizer is emptied.
- Where possible, air movement should be from clean to dirty areas (see [paragraphs 6.41–6.42](#)).
- A wash-hand basin should be provided for use by staff at the completion of each stage in the decontamination process. Where this work is conducted adjacent to the treatment area, it is acceptable for a single wash-hand basin to

be used for this and clinical hand-washing. However, this basin should be distinctly separate from the sinks used in decontamination.

- Where a double-ended washer-disinfector is used, the input door in the dirty area and that used to empty the clean instruments should be separated by a barrier. Alternatively, the washer-disinfector should be built directly into the separating wall between the dirty and clean areas.
- 5.8 This guidance recognises that, because of physical limitations on space, it may take longer for some practices to meet the **best practice** requirements. In areas where building alterations to existing premises are restricted and/or purpose-built premises may be difficult or impossible to acquire, **best practice** may not be achievable.

6 General hygiene principles

Hand hygiene

- 6.1 The term hand hygiene covers not only hand-washing, but also alternative and additional measures such as hand disinfection using antibacterial-based hand-rubs/gels.
- 6.2 Hand hygiene is crucial in preventing the spread of infection and the recontamination of surgical instruments and devices. Clean hands are an essential counterpart to the use of gloves. Neither measure is a substitute for the other.
- 6.3 As part of **essential quality requirements**, training in hand hygiene should be part of staff induction and be provided to all relevant staff within dental practices periodically throughout the year.
- 6.4 Hand hygiene should be practised at the following key stages in the decontamination process so as to minimise the risk of contamination:
- before and after each treatment session;
 - before and after the removal of PPE;
 - following the washing of dental instruments;
 - before contact with instruments that have been steam-sterilized (whether or not these instruments are wrapped);
 - after cleaning or maintaining decontamination devices used on dental instruments;
 - at the completion of decontamination work.
- 6.5 Mild soap should be used when washing hands. Bar soap should not be used. Apply the liquid soap to wet hands to reduce the risk of irritation, and perform hand-washing under running water. Ordinarily, the hand-wash rubbing action should be maintained for about 15 seconds. After the exercise, the hands should be visibly clean. Where this is not the case, the hand hygiene procedure should be repeated.

Drying of hands

- 6.6 Effective drying of hands after washing is important because wet surfaces transfer

microorganisms more easily than when they are dry, and inadequately dried hands are prone to skin damage. To prevent recontamination of washed hands, disposable paper towels should be used.

Skin care

- 6.7 Hand cream, preferably water-based, should be used to avoid chapped or cracking skin. Communal jars of hand cream are not desirable as the contents may become contaminated and subsequently become an infection risk. Ideally, wall-mounted hand-cream dispensers with disposable cartridges should be used. Any staff that develop eczema, dermatitis or any other skin condition should seek advice from their occupational health department or general practitioner (GP) as soon as possible.
- 6.8 Fingernails should be kept clean, short and smooth. When viewed from the palm side, no nail should be visible beyond the fingertip. Staff undertaking dental procedures should not wear nail varnish and false fingernails.
- 6.9 Rings, bracelets and wristwatches should not be worn by staff undertaking clinical procedures. Staff should remove rings, bracelets and wristwatches prior to carrying out hand hygiene. A wedding ring is permitted but the skin beneath it should be washed and dried thoroughly, and it is preferable to remove the ring prior to carrying out dental procedures.

Facilities and procedures for hand-washing

- 6.10 In accordance with the advice above, a separate wash-hand basin should be provided:
- The basin should not have a plug or an overflow and be fitted with a remote running trap (that is, the U-bend is not directly under the plughole).
 - It should have a sensor-operated or lever-operated mixer tap.
 - Taps should not discharge directly into the drain aperture as this might generate aerosols.

6.11 Wall-mounted liquid hand-wash dispensers with disposable cartridges should be used. It should be ensured that the nozzle is kept clean. Refillable hand-wash containers should not be used as bacteria can multiply within many of these products and are therefore a potential source of contamination.

6.12 Hand hygiene is an essential part of preventing infection in the practice. A cleanable poster depicting a six- or eight-step method should be displayed above every clinical wash-hand basin in the practice (see [Section 3](#)).

Personal protective equipment for decontamination processes

6.13 The local infection control policy should specify when personal protective equipment (PPE) is to be worn and changed. PPE training should be incorporated into staff induction programmes.

6.14 Appropriate PPE should be worn during decontamination procedures. PPE includes disposable clinical gloves, household gloves, plastic disposable aprons, face masks, eye protection and

adequate footwear. PPE should be stored in accordance with manufacturers' instructions.

6.15 When used appropriately, and in conjunction with other infection control measures, PPE forms an effective barrier against transmission of infection.

Gloves

6.16 Gloves are needed:

- to protect hands from becoming contaminated with organic matter and microorganisms;
- to protect hands from certain chemicals that will adversely affect the condition of the skin. Particular care should be taken when handling caustic chemical agents, particularly those used in disinfection and for washer-disinfectors;
- to minimise the risks of cross-infection by preventing the transfer of organisms from staff to patients and vice-versa.

6.17 Used gloves should be replaced before performing activities that require strict aseptic precautions or when touching equipment that is difficult to clean.



A separate wash-hand basin should be provided for use by staff conducting decontamination. This basin should be distinctly separate from the sinks used in decontamination



PPE includes disposable clinical gloves, plastic disposable aprons, face masks and eye protection

- 6.18 It is important that gloves fit properly if they are to produce the level of protection against the expected contaminants. The use of latex gloves is subject to a Health & Safety Executive recommendation, which calls for local risk assessment. This is partly attributable to reports of long-term allergy development in some users. The use of vinyl or nitrile gloves may be a satisfactory substitute and should be made available to staff within the practice.
- 6.19 Powdered gloves should not be used. Individuals who are sensitised to natural rubber latex proteins and/or other chemicals in gloves should take advice from their GP or occupational health department for an alternative to latex gloves.
- 6.20 All disposable clinical gloves used in the practice should be CE-marked and should be:
- low in extractable proteins (<50 µg/g);
 - low in residual chemicals;
 - powder-free.
- 6.21 Gloves other than domestic household types are single-use only. They should be discarded as clinical waste.
- 6.22 Jewellery (for example watches, dress rings, bracelets etc) may damage the integrity of the glove and may pose an infection risk.
- 6.23 The following additional guidance is provided:
- Long or false nails may also damage the glove, so keep nails short and clean.
 - Glove integrity can be damaged if in contact with substances such as isopropanol or ethanol; therefore, alcohol rubs/gels should not be used to decontaminate gloves.
 - Gloves (except household gloves) should not be washed as liquids may be absorbed into the glove and compromise the efficacy of the barrier.
 - Storage of gloves should follow manufacturers' recommendations.
 - Domestic household gloves, if used, should be washed with detergent and hot water and left to dry after each use to remove visible soil. Replace these gloves weekly or more frequently if worn or torn or if there is any difficulty in removing soil.

Disposable plastic aprons

- 6.24 These should be worn during all decontamination processes.
- 6.25 Aprons should be used as a single-use item and disposed of as clinical waste. Plastic aprons should be changed at the completion of each procedure.

Face and eye protection for decontamination procedures

- 6.26 During cleaning procedures, there is a risk of contaminated fluids splashing onto the face and into the eyes. Therefore, the dental team should ensure protection of their mucosa from splashes and other contaminated fragments that may escape during these procedures.
- 6.27 Face masks are single-use items and should be disposed of as clinical waste.
- 6.28 Spectacles do not provide sufficient eye protection unless specifically designed for the purpose. It is advisable to wear a visor or face shield over spectacles; this gives added protection for prescription glasses.
- 6.29 Eye protection may be reusable but is often difficult to clean. It may be reused if cleaned according to manufacturers' instructions. This should take place when it becomes visibly dirty and/or at the end of each session. Disposable visors are available and may be used.
- 6.30 Footwear should be fully enclosed, in good order and comply with health and safety guidance. Particular care should be taken concerning the risk of chemical or hot water spillage onto feet.

Clothing, uniforms and laundry

- 6.31 A wide variety of clothing is worn in dental surgeries and in many practices is used to reinforce the corporate image. Overall guidance is provided in DH's (2006) 'Uniforms and workwear: an evidence base for developing local policy'.
- 6.32 Clothing worn to undertake decontamination should not be worn outside the practice; adequate changing and storage facilities that are accessible from the decontamination area should be provided. A similar approach is recommended for clinical clothing.
- 6.33 Short sleeves allow the forearms to be washed as part of the hand hygiene routine. Dental staff need to be aware of the hazards that may be encountered in the decontamination process and may wish to

wear long-cuffed gloves or disposable long-sleeved gowns to protect their arms.

- 6.34 Clothing/uniforms can become contaminated with microorganisms during procedures. It is important that freshly laundered uniforms are worn everyday. Sufficient uniforms for the recommended laundry practice should be provided, as staff who have too few uniforms may be tempted to reduce the frequency of laundering.
- 6.35 Uniforms and workwear should be washed at the hottest temperature suitable for the fabric to reduce any potential microbial contamination (see the Department of Health's (2010) 'Uniforms and workwear: guidance on uniform and workwear policies for NHS employers').

Removal of PPE

- 6.36 Depending on the type of PPE worn, items of PPE should be removed in the following order:
- Gloves should be removed first (so that the gloves end up inside-out). Make sure hands do not get contaminated when removing gloves. Wash hands thoroughly, if visibly contaminated, before removing the rest of the PPE.
 - Plastic disposable apron. The plastic apron is removed by breaking the neck straps and carefully gathering the apron together by touching the inside of the apron only. Avoid touching the outer contaminated area.
 - Face mask. Remove the mask by breaking the straps or lifting over the ears and dispose of into a clinical waste receptacle (see HTM 07-01). Avoid touching the outer surface of the mask and do not crush the mask before disposal. Masks should never be left to hang around the neck and should be disposed of immediately after use.
 - Face and eye protection. Take care not to touch the outer surfaces. Single-use eye protection should be disposed of into the clinical waste receptacle.
 - Wash hands thoroughly again.

Surface and equipment decontamination

General

- 6.37 Surfaces and equipment used in the decontamination of dental instruments should

be cleaned carefully before and after each decontamination process cycle. The procedure used should comply with written local policies.

- 6.38 All surfaces should be such as to aid successful cleaning and hygiene. Wherever possible, surfaces (including walls) should be continuous and free from damage and abrasion. They should be free from dust and visible dirt.

Environmental conditions

- 6.39 The environmental conditions in decontamination facilities should be controlled to minimise the likelihood of recontamination of sterilized instruments. Key considerations include the cleanability of surfaces, fittings and equipment.
- 6.40 Ventilation and air quality are important considerations. In non-purpose-built facilities, the control of airflow is a challenging issue. Responsible persons (see [Section 3](#)) will need to consider how good standards can be achieved without resorting to unreasonably complex or expensive ventilation systems. Through-wall fan-based ventilation and extraction units will often be useful in this context. In particular, cassette-based systems can be simple to install and produce a balanced airflow at low cost. The use of free-standing or ceiling-mounted fan units, however, is not recommended.
- 6.41 Mechanical ventilation systems may be advantageous, particularly where **best practice** requirements are being pursued. However, these systems can be expensive in terms of both capital and running costs. Accordingly, designs that make best use of natural ventilation in clinical areas may be advantageous, while the use of simple fan-based systems in decontamination areas will be helpful. It should be remembered that protecting against recontamination of instruments is always a key aim.

Detailed guidance can be found in BS 5925:1991.

- 6.42 The ventilation system in the decontamination area or room(s) should be designed to supply reasonable quantities of fresh air to the positions where persons work and to remove excess heat from equipment and processes.
- 6.43 Where used, mechanical extract units should be ceiling- or wall-mounted. Care should be taken to ensure that airflow is from clean to dirty.
- 6.44 Where full mechanical ventilation solutions are used, the extract system should be located and sized

to draw about one-third of the air across the decontamination benches in the clean-to-dirty direction.

- 6.45 Mechanical ventilation equipment should include coarse air filtration on the input side. This will require periodic maintenance. Practices are advised to consult a heating and ventilation engineer if choosing to install a mechanical ventilation system.

Surfaces and equipment – key design issues

- 6.46 All work surfaces where clinical care or decontamination is carried out should be impervious and easily cleanable. They should be jointless as far as is reasonable; where they are jointed, such joints should be welded or sealed.
- 6.47 Flooring in clinical care and decontamination areas should be impervious and easily cleanable. Carpets, even if washable, should not be used. Any joins should be welded or sealed. Flooring should be coved to the wall to prevent accumulation of dirt where the floor meets the wall
- 6.48 It should be ensured that surfaces:
- can be easily accessed;
 - will dry quickly.
- 6.49 Manufacturers' advice should be sought in terms of the compatibility of detergents and disinfectants with the surface materials used.

Decontamination equipment

- 6.50 Specialist items of equipment (for example, ultrasonic baths, washer-disinfectors, sterilizers and RO machines) may require cleaning and decontamination processes that are purpose-designed.
- 6.51 Although information will be provided by manufacturers, it is recommended that, when writing local protocols, assistance is sought from a qualified decontamination engineer or other trained person. This may be a Competent Person (Decontamination) employed by the equipment provider or local sterile services department (SSD). In the latter case, it should be possible to contact the local Competent Person (Decontamination) via the Institute of Healthcare Engineering and Estate Management (IHEEM).
- 6.52 Planned cleaning programmes will have links to preventive maintenance and the validation process. Local policies should reflect these requirements and

clearly state the intervals at which actions are to be taken and a procedure for the keeping of records.

- 6.53 It is often during cleaning work that minor defects, wear or damage to equipment will be detected. Local policies should ensure that such defects are reported to the responsible person.

For floor and general surface cleaning, the national colour coding scheme for cleaning materials and equipment in primary care medical and dental premises may be useful:

- red – for wash-rooms;
- blue – for offices;
- green – for kitchens;
- yellow – for clinical and decontamination areas.

Cleaning protocols and techniques

- 6.54 The dental practice should have a local protocol clearly outlining surface- and room-cleaning schedules. The cleaning process will be most effective if the more contaminated areas are cleaned first. Materials and equipment used to clean clinical areas and other higher-risk areas should be stored separately from those used for general and non-clinical areas. Simple records should be maintained in accordance with the [Code of Practice](#).
- 6.55 Cleaning staff should be briefed on the special measures to be observed in cleaning of patient care areas or room(s) used for decontamination. In some instances, full training of personnel will be needed.
- 6.56 If instruments become contaminated (through, for example, being dropped or being placed in a dirty area), they should be sent for further reprocessing.
- 6.57 The use of disinfectant or detergent will reduce contamination on surfaces. If there is obvious blood contamination, the presence of protein will compromise the efficacy of alcohol-based wipes.

Note

Alcohol has been shown to bind blood and protein to stainless steel. The use of alcohol with dental instruments should therefore be avoided.

- 6.58 It is not good practice to refill spray bottles used to apply cleaning or disinfecting solutions. Bacteria can contaminate the bottles and become adapted to these solutions and grow in the spray mechanisms

(Ehrenkranz et al., 1980; Sautter et al., 1984). Such bottles, whether supplied pre-filled or empty, should be single use.

- 6.59 Local provision of steam cleaning from practice resources is unlikely to be economical. Instead the use of a contractor may be advantageous.
- 6.60 Cleaning equipment should be stored outside patient care areas.

Decontamination of treatment areas

- 6.61 The patient treatment area should be cleaned after every session using disposable cloths or clean microfibre materials – even if the area appears uncontaminated.
- 6.62 Areas and items of equipment local to the dental chair that need to be cleaned between each patient include:
- local work surfaces;
 - dental chairs;
 - curing lamps;
 - inspection lights and handles;
 - hand controls including replacement of covers;
 - trolleys/delivery units;
 - spittoons;
 - aspirators;
 - X-ray units.

Note

Dental chairs should be free from visible damage (for example rips and tears).

- 6.63 Areas and items of equipment that need to be cleaned after each session include:
- taps;
 - drainage points;
 - splashbacks;
 - sinks.

In addition, cupboard doors, other exposed surfaces (such as dental inspection light fittings) and floor surfaces, including those distant from the dental chair, should be cleaned daily.

Note

Spittoons and aspirating units need to be washed through at the end of a session according to manufacturers' instructions.

- 6.64 Items of furniture that need to be cleaned at weekly intervals include:
- window blinds;
 - accessible ventilation fittings;
 - other accessible surfaces such as shelving, radiators and shelves in cupboards.
- 6.65 Purpose-made disposable single-use covers are available for many of the devices mentioned above, including inspection light handles and headrests. The use of these is encouraged but should not be taken as a substitute for regular cleaning. Covers should be removed and surfaces should be cleaned after each patient contact.
- 6.66 For infection control reasons, in clinical areas:
- covers should be provided over computer keyboards; or
 - conventional keyboards should be replaced with “easy-clean” waterproof keyboards as recommended in the Department of Health's (2008) 'Clean, safe care: reducing infections and saving lives'.

Where covers or conventional keyboards are provided, care should be taken to ensure that covers are changed or that washing is performed at frequent intervals. This should be regarded as a useful priority.

- 6.67 Cleaning centres on simple techniques using disposable cloths wetted with clean water and a detergent.
- 6.68 Dry cleaning should be avoided wherever possible as this may result in dust suspension.
- 6.69 Care should be taken to keep water well away from electrical devices, even though many of those provided in dentistry will have water-resistant housings.
- 6.70 After some clinical procedures, it is necessary to start cleaning as soon as care of the individual patient is complete. In these cases, staff should not wait until the end of the session to start cleaning the area.

- 6.71 Portable aspirators with reservoir bottles are not recommended. They are not fitted with filters and pose a considerable hazard when disposing of the contents.
- 6.72 Intra-oral radiology film and devices used in digital radiology imaging are potential sources of cross-infection. Accordingly, where reusable devices are used, they should be decontaminated in accordance with the manufacturer's instructions. For intra-oral holders, this will require the use of steam sterilization following washing and disinfection.
- 6.73 Soft toys are often difficult to clean and should accordingly not be provided within practices.
- 6.74 For blood spillages, care should be taken to observe a protocol that ensures protection against infection. The use of hypochlorite at 1000 ppm available chlorine is recommended. Hypochlorite should be made up either freshly using hypochlorite-generating tablets or at least weekly in clean containers. Contact times should be reasonably prolonged (not less than five minutes). A higher available chlorine concentration of 10,000 ppm is useful, particularly for blood contamination. The process should be initiated quickly and care should be taken to avoid corrosive damage to metal fittings etc. The use of alcohol within the same decontamination process is not advised.

Dental unit water lines (DUWLs)

Note

In view of the expertise required in this specialised field, practices (through the Registered Manager) should engage with an external specialist to assist in meeting the recommendations given in [Section 3](#) of this guidance. This may be a locally-based engineering consultant with specialist knowledge of *Legionella* and other water-borne organisms.

General

- 6.75 Best practice guidelines on the control of *Legionella* are provided in the Health & Safety Commission's 'Legionnaires' disease – the control of *Legionella* bacteria in water systems. Approved Code of Practice & guidance' (also known as L8) and Health Technical Memorandum 04-01 – 'The control of *Legionella*, hygiene, "safe" hot water, cold water and drinking water systems'.

Note

The Health & Safety Commission's Approved Code of Practice L8 gives practical advice on how to comply with UK health and safety law with respect to the control of *Legionella* bacteria. This Code is important in that it has a special legal status. If a healthcare organisation is prosecuted for a breach of health and safety law, and it is held that it did not follow the relevant provisions of the Code, that organisation would need to demonstrate that it had complied with the law in some other way, or a court would find it at fault.

- 6.76 The use of water in dentistry must comply with a series of regulations which are designed to ensure the safety of patients, staff and the public. The application of these regulations and codes is covered in detail in [Chapter 19](#) of this guidance.
- 6.77 The Registered Manager (see [paragraph 9.3](#)) should ensure that arrangements are made such that the practice can continuously achieve compliance with the requirements of these regulations. Registration with the Legionella Control Association or other recognised body is recommended.

Microbiological monitoring

- 6.78 Apart from situations where there are indications from taste or odour, microbiological monitoring using dip slides for total viable counts (TVCs) is not considered essential. However, some companies and other institutions offer comprehensive water-purification services that include periodic microbiological sample monitoring. Such services, provided they are quality-controlled, may contribute usefully to risk reduction in this area.
- 6.79 Where monitoring is undertaken, the TVC should be expected to lie in the range 100 to 200 colony forming units per millilitre (cfu/ml). In general, incubation should be at 22°C. These measurements can be carried out by commercial microbiological services or by Public Health England. (Some commercial water-purification services offer microbiological control such that TVC values may be maintained below 10 cfu/ml.)

Note

This is a complex procedure and the use of in-house test kits is not recommended.

DUWLs

- 6.80 No currently available single method or device will completely eliminate biocontamination of DUWLs or exclude the risk of cross-infection. To reduce contamination risk, a combination of methods is applicable.
- 6.81 With regard to *Legionella* and other water-borne pathogenic agents, the HCAI Code of Practice (2009) states:
“Premises should be regularly reviewed for potential sources of infection and a programme should be prepared to minimise any risks. Priority should be given to patient areas although the exact priority will depend on local circumstances”.
- 6.82 Guidance from L8 advises that at-risk systems, particularly those used with the patient, be drained down at least at the end of each working day. Where manufacturers provide protocols for daily cleaning, these should be applied.
- 6.83 Self-contained water bottles (bottled water system) should be removed, flushed with distilled or RO water and left open to the air for drying overnight. They should be stored inverted.
- 6.84 Where visual contamination is present, flushing with a suitable disinfectant followed by thorough washing is necessary. The manufacturer’s instructions will specify the disinfectant to be used and may also require the continuous presence of antimicrobial agents to prevent the build-up of biofilms.

Note

The self-contained water supplies used with dental care systems should be distilled or RO water (see [Section 3](#)). Certain systems recycle water back to a storage facility. Where this is done, repurification will be necessary at each cycle.

If self-contained water bottles are not used, a Type A air gap should separate the DUWLs from the mains water supply. Such arrangements should be subject to consideration of local water quality, particularly where hard water is used.

- 6.85 DUWLs should be flushed for at least two minutes at the beginning and end of the day and after any significant period when they have not been used (for example, after lunch breaks). In addition, they should also be flushed for at least 20–30 seconds between patients. Whilst these actions have been shown to have only a small effect on biofilm build-

up within the DUWL system, they do usefully reduce microbiological counts in the water delivery tube during the period when patients are likely to be exposed. Some water-purification systems are capable of supplying DUWLs and may be able to reduce microbiological risks.

Note

Care should be taken to minimise the occurrence of splashing and aerosol formation.

- 6.86 Disinfection of DUWLs should be carried out periodically. In all cases, the manufacturer’s instructions should be consulted. Sodium hypochlorite and isopropanol and a number of other agents have been shown to be effective in the removal of biofilm as well as the reduction of microbacterial contamination. However, these agents should only be used where recommended by manufacturers. If they are used, care should be taken to ensure that DUWLs are thoroughly flushed after disinfection and before being returned to clinical use.

Notes

- (1) There is disagreement within the scientific literature concerning the effectiveness of water-based flushing of DUWLs, particularly in respect of biofilm control. For systems making use of potable water (that is, where the water supply is drawn from a mains water system), the nature of the building’s water-supply arrangements may be an important consideration. This is particularly so where storage tanks are used. Where delivered water quality is in doubt, dental practices should consider adopting continuous dosing systems if permitted by the DUWL manufacturer’s recommendations. If dosing is used, it is important to ensure that the dose rates delivered are within the recommended safe limits for the product used. Dental practices that use a potable water option – through air-gap supply or the use of bottles – should consult with their appointed Competent Person in respect of local water quality and suitability.
- (2) For those using purified water, such as distilled or RO, possibly with UV treatment, the rate of biofilm build-up is likely to be low, provided that water lines are regularly disinfected and maintained.

(3) Particular caution should be taken with regard to dental handpieces where dosing is applied, as a number of instances of damage have been reported.

- 6.87 Dental equipment requiring protection against backflow should have anti-retraction valves incorporated on all handpieces, ultrasonic scalers and/or water lines (see [Section 3](#)). Responsible persons should ensure these are fitted where required. They must be regularly monitored and maintained.
- 6.88 Examples of dental equipment requiring backflow protection are:
- dental spittoons;
 - three-in-one syringes;
 - wet-line suction apparatus; and
 - self-filling automatic radiographic processors (where still used).

Adherence to the equipment manufacturer's recommended cleaning procedures, including the use of the manufacturer's recommended chemicals, is a requirement for medical devices such as those listed above.

- 6.89 Where in-line filters are used, these will require treatment using an appropriate cleansing solution at intervals recommended by the manufacturer – but always at the end of each session. This step should be performed after first flushing the DUWL.
- 6.90 If the DUWL has disposable filters, they should be replaced daily.

See [Section 3](#) for further guidance on DUWLs.

- 6.91 **For dental surgical procedures, surgical flaps or other access into body cavities involving irrigation, the use of sterile water or sterile isotonic saline provided from a separate single-use source is recommended.**

7 Impressions, prostheses and orthodontic appliances

7.1 Decontamination of these devices is a multi-step process to be conducted in accord with the device or material manufacturer's instructions. In general terms, the procedure will be as follows:

- a. Immediately after removal from the mouth, any device should be rinsed under clean running water. This process should continue until the device is visibly clean.
- b. All devices should receive disinfection according to the manufacturer's instructions. This will involve the use of specific cleaning materials

noted in the CE-marking instructions. After disinfection, the device should again be thoroughly washed. This process should occur before and after any device is placed in a patient's mouth.

- c. If the device is to be returned to a supplier/ laboratory or in some other fashion sent out of the practice, a label to indicate that a decontamination process has been used should be affixed to the package.

Section 3: Engineering, technology and standards

8 Regulatory framework and compliance

BS/EN/ISO Standards

- 8.1 BS EN Standards for sterilization were first published in 1994. They included:
- BS EN 285 on larger steam sterilizers;
 - BS EN ISO 17665 on the monitoring of steam sterilization; and
 - BS EN 556 on the definition of sterilization.
- 8.2 Subsequent standards covered benchtop sterilizers (BS EN 13060).
- 8.3 Reviews and rewrites of the above Standards coupled with the production of new Standards has led to a revision of the content of Health Technical Memoranda – including this document – in order to bring their content in line with that of the BS/EN/ISO Standard portfolio.
- 8.4 A list of these Standards is provided in the References. It is in the light of these changes that this Health Technical Memorandum is published. Reference to the content of a relevant Standard is made where necessary but the content of that Standard is not included in this document.

DH guidelines

- 8.5 Guidance produced by DH for decontamination has evolved in recent years.
- 8.6 Advice on decontamination of medical devices was issued in HSC 2000/032 and in 'Decontamination of reusable medical devices in primary, secondary and tertiary care sectors (NHS and Independent providers)' 2007.
- 8.7 The Chief Dental Officer's letter (April 2007) advised the single-use of all endodontic files and reamers, as well as any other instruments for which effective decontamination was difficult. This was reinforced by the release of 'Potential vCJD transmission risks via dentistry. An interim review' (December 2007).
- 8.8 Health Technical Memorandum 01-05 has drawn upon all guidance issued previously, including HSG (93)40 'Protecting health care workers and patients from hepatitis B'.
- 8.9 It is issued specifically to improve standards in decontamination for primary care dental practices, where decontamination is carried out locally within the practice.
- 8.10 Advice to the secondary sector was provided by policy document 'Decontamination of reusable medical devices in the primary, secondary and tertiary care sectors (NHS and Independent providers)'. This document required demonstration of compliance with the "essential requirements" of the Medical Devices Regulations and gave the following four options for the decontamination of reusable medical devices:
- ensure all sites of decontamination comply to these essential requirements;
 - use single-use devices;
 - outsource decontamination to an accredited SSD;
 - a combination of the above.
- 8.11 Health Technical Memorandum 01-05 sets out the requirements for the first of the above options.

Healthcare regulation by the Care Quality Commission

The regulation of the provision of health and adult social care became the responsibility of the Care Quality Commission (CQC) on 1 April 2009. Cleanliness and infection control, including decontamination, is a requirement for registration and has applied to all primary care dental providers since 1 April 2010.

Appendix B of the December 2010 version of the [Code of Practice](#) is specifically related to dental practices. It takes due note of the guidance in this Health Technical Memorandum and does not impose any additional burdens on decontamination.

9 Staff roles and responsibilities in decontamination

- 9.1 It is essential that all staff involved in decontamination are suitably trained and have their roles and responsibilities defined and that everyone is aware of each other's responsibilities.
- 9.2 Choice Framework for local Policy and Procedures 01-01 Part A provides general advice – for the acute sector – on these responsibilities along with the experience, qualifications and training required. However, that advice is based on a universal application to decontamination in complex systems which are probably inappropriate to primary care dental practices.
- 9.3 Each practice can, therefore, establish its own system concerning staff responsibilities but will be expected to demonstrate the same degree of understanding, competency and management as required by Choice Framework for local Policy and Procedures 01-01 Part A. The following may be used as a guide to these roles. The terminology of Part A is used for clarity but it is likely that local personnel may have differing titles. Small practices may be unable to appoint all these responsible posts and a local decision regarding them will need to be made. Essentially, a practice should be able to demonstrate the following responsibilities:
- an understanding of legal liabilities and current best practice;
 - it has obtained professional advice, where necessary, in equipment purchase, maintenance, testing and operation;
 - it can evidence the performance of all relevant maintenance and testing duties;
 - it can demonstrate compliance with the Pressure Systems Safety Regulations 2000.

It should be borne in mind that it is likely that one individual may carry out two, or possibly more, of the following roles.

Registered Manager (Executive Management): this will be the individual with ultimate responsibility for decontamination equipment ownership and the definition and appointment of

the following staff. In a dental practice, this could be the NHS contractor, practice owner or a person of similar authority.

Decontamination Lead: the [Code of Practice](#) makes it a requirement that an individual is given the responsibility for infection control and decontamination. This person should have the experience and authority to perform this task and should be accountable to the Registered Manager.

Designated Person: this role acts as the interface between the practice and support services supplied externally, including service, maintenance and testing. This could be the general manager of the practice. The Decontamination Lead could also act as the Designated Person.

Authorising Engineer (Decontamination): this is an external role that provides guidance and advice on the compliance issues of decontamination, including the implementation of this Health Technical Memorandum and associated guidance documentation. A list of suitable persons is available from the voluntary register held by the Institute of Healthcare Engineering and Estate Management (IHEEM) (<http://www.iheem.org.uk/Technical-Platforms>).

Authorised Person (Decontamination): the Authorised Person provides technical support to the Competent Person and liaises with the Authorising Engineer. The Authorised Person may be directly employed by the practice or provided by a third party.

Competent Person (Decontamination): the Competent Person is responsible for the servicing, testing and maintaining of the decontamination equipment within the practice. The Competent Person may be directly employed by the practice or provided by a third party.

Competent Person (Pressure Systems): each practice will have a legal responsibility for the safety of its decontamination equipment, particularly the sterilizers that are pressure vessels. The need for insurance and a Written Scheme of Examination is a legal liability and can be provided by the

Competent Person (Pressure Vessels). This is likely to be provided by an insurance company.

Service engineer: a person provided under a service level agreement or contract who is certified by the service agent or equipment manufacturer to be competent to both service and test specified decontamination equipment. This person may, among other duties, perform validation tests in accordance with the EN standards cited in this document. The service engineer may give an opinion on the outcomes of validation testing as well as providing data to an Authorising Engineer (Decontamination) or Authorised Person (Decontamination) for validation approval.

User: this person has day-to-day responsibility for the management of the decontamination equipment and processes. A likely overlap may mean that this role is duplicated, but the responsibility must be demonstrated. An important function of the User is to ensure that anyone operating and testing decontamination equipment (that is, an Operator) is suitably trained and competent.

The User should seek advice from manufacturers or the service engineer on how to carry out the testing of equipment and daily tasks.

With regard to infection control, the User should seek advice from infection control teams, which may consist of a microbiologist or control of infection officer.

Operator: this is the person with authority to operate decontamination equipment. This person will also carry out daily and weekly periodic tests.

Manufacturer: the manufacturer, supplier or agent of any decontamination equipment

Purchaser: the purchaser of any decontamination equipment – likely to be the practice.

- 9.4 In addition to these roles the practice may require specialist clinical advice and guidance and should possess the ability to source the following responsibilities, either within the practice or externally.

Control of Infection Officer: advice regarding infection prevention and control and the ability to audit and implement relevant advice.

Microbiologist (Decontamination): while most decontamination processes are a matter of parametric management and control (that is, ensuring that values of key measurements or indicators are within a specified range for decontamination), advice from a **Microbiologist (Decontamination)** may be required for certain procedures and practices. This advice should be sought where the practice is in doubt about its relevance. Access to a Microbiologist can be made via institutions that employ such professionals. This would include acute trusts, pathology departments and Public Health England laboratories.

- 9.5 The Registered Manager should ensure that all personnel fulfilling the roles defined above should receive appropriate training, that they can demonstrate competency in their duties and that individual training records for all staff are retained. Training should always be supported by defined learning outcomes and competencies and may include, where appropriate, the following:
- an understanding of the whole decontamination process;
 - an understanding of their roles and those of others;
 - an understanding of the need for infection control and all relevant infection control policies and procedures;
 - an understanding of, and an ability to perform, periodic testing where appropriate.
- 9.6 Full identification of the individuals fulfilling these roles should be documented. It may be acceptable if staff of other titles fulfil the responsibilities as long as the post-holder's authority and experience is sufficient for their full implementation.
- 9.7 It is likely in a dental facility that the roles above will be provided by a number of entities/ organisations. All roles should thus be identified and all individuals aware of each other. The systematic approach to these roles should ensure that they function correctly and that they are not individual-based but can withstand changes of personnel without affecting the systematic approach. Advice on relevant training programmes is available from the Authorising Engineer (Decontamination).

10 Procurement of decontamination equipment and instruments

Note

In addition to the guidance given in this chapter, readers may also find Scottish Dental's website useful. On its decontamination page, it has included a list of decontamination equipment that has been tested and approved for use in dental practices, and which is used in the [national contract in Scotland](#).

Determining the load to be processed

- 10.1 In order to ensure full compatibility of the equipment with the decontamination process, the need for packaging and storage should be considered, as this will affect the type of air-removal process and therefore the type of sterilizer chosen (vacuum or displacement).
- 10.2 For the cleaning process, instrument design will also affect the choice of cleaning process, particularly regarding loading carriages for thermal washer-disinfectors.
- 10.3 If cannulated devices are to be cleaned, ultrasonic irrigators (that is, ultrasonic cleaners with the additional ability to clean and flush internal channels of cannulated devices) or loading carriages with lumen connections may be required.
- 10.4 In addition to the types of load items:
 - their quantities should also be assessed. This will enable the number of equipment items to be determined;
 - realistic cycle times should be assumed when capacity planning is calculated;
 - it should be remembered that all decontamination equipment will require maintenance, servicing and testing – reasonable time during the normal working day should be set aside for these procedures;
 - all capacity planning should be documented.

Note

Periodic testing for washer-disinfectors, sterilizers and ultrasonic cleaners can take up to a full session. Accordingly Registered Managers should plan schedules to allow for this, particularly if the equipment is located close to clinical areas. (The process effectively takes a machine out of use for that session.) Times will be different for sterilizer types N, B and S. Removal, or disablement, of unwanted cycles on multi-cycle machines can help to reduce this.

Decontamination equipment: washer-disinfectors and sterilizers

- 10.5 Decontamination equipment should be procured against the relevant Health Technical Specification (formerly, Model Engineering Specification). These are currently available for washer-disinfectors and sterilizers.
- 10.6 Advice on completing the specifications for sterilizers and washer-disinfectors and on the production of a specification for ultrasonic cleaners/irrigators is available from the Authorising Engineer (Decontamination).

Note

All Model Engineering Specifications are being progressively revised and retitled as Health Technical Specifications (HTS).

- 10.7 New decontamination equipment should display a CE mark (see below) to demonstrate compliance with the Medical Devices Regulations 2002.



10.8 When selecting new equipment, the size, model and type should be considered against workload and throughput requirements, together with the availability of space and the service infrastructure available.

10.9 Further consideration should also be given to the following:

- What are the delivery and acceptance requirements?
- Will the equipment selected be fit for purpose and is it compatible with other equipment in use?
- What are the manufacturer's recommendations for staff/operator training and cleaning, and will they be achievable in practice?
- Does it have an automated cleaning process?
- What cleaning agents are recommended and will they comply with COSHH and health and safety requirements?
- What commissioning and validation is required for the equipment? What are the ongoing costs?

10.10 The following will also need consideration:

- testing: there will be a need to identify who is to perform the testing, and where and when testing is to be performed;
- service response: there is a need to be clear about service-response times in the event of breakdown;

Note

In general terms, as primary-care dentists may not have in-house engineering staff, robust contractual arrangements to ensure breakdown cover, routine maintenance and continuity of validation will be needed.

- process data capture (that is, chart recorder/data recorder/printer): this information is needed to clarify the audit process on product release – manual recording of displayed parameters at the end of a cycle should be recorded to an appropriate log.

10.11 The equipment should come with an easily-readable operating, maintenance and technical manual that includes:

- make, model, serial number and installation and warranty requirements;
- an explanation of the purpose of the equipment and the cycles;
- suitable chemicals to be used with the equipment;
- optimum working temperatures;
- cleaning instructions (stipulating suitable detergents) for the user;
- safety instructions, including lifting and handling, PPE requirements etc;
- explanation of warning indications (cycle failure etc) and fault-finding (diagnostic) procedures;
- all maintenance requirements (easily copied so that it can be displayed and undertaken by an operator) including frequencies etc;
- monthly maintenance requirements;
- yearly testing and validation requirements/procedures;
- consumable parts list and spares components list incorporating identification numbers.

10.12 Information on periodic testing protocols can be found in [Chapters 12–14](#). These chapters also provide advice on the required actions if tests indicate unacceptable results.

Decontamination equipment: ultrasonic cleaners

10.13 The following are more specific considerations when procuring ultrasonic cleaners.

10.14 Ultrasonic cleaners can be freestanding or integral to the washer-disinfector.

10.15 They should comply with the electrical safety specifications given in BS EN 61010-1.

10.16 Consideration should be given to the:

- voltage (V) supply of the equipment (single 230 V or three-phase 400 V) to help establish whether the electrical infrastructure needs modification;
- power (kW/h) consumption of the equipment (this will help to establish running costs).

10.17 Ultrasonic cleaners may be designed to operate at a single frequency, across a frequency range, and/or with a controlling system to adjust the frequency in response to the loading conditions.

10.18 Siting of the ultrasonic cleaner within the workplace should be in a defined area, following a strict dirty-to-clean workflow.

10.19 It should be easy to wipe down and disinfect the ultrasonic cleaner.

10.20 An ultrasonic cleaner needs to be maintained by a Competent Person (Decontamination) or a suitably qualified person.

Specifications

10.21 When procuring ultrasonic cleaners, the following specification points should be considered:

- a reservoir (or tank) large enough to accommodate the required throughput;
- a reservoir that should be of a polished stainless-steel construction with internal rounded edges/corners to aid in the cleaning process;
- the maximum and minimum fluid levels clearly visible to the user marked on the reservoir;
- a reservoir drainage facility that does not affect performance and does not leave pools of fluid in the reservoir, which allows the tank to be emptied without the need for operatives to put their hands in the fluid;
- an integral purpose-built holding basket, which enables all equipment to be held within the ultrasonic bath in the optimum position so that micro-dental instruments or instruments with fine points are not blunted by the impacts resulting from fine mechanical shaking;
- a hinged auto-locking lid that prevents interaction with the load once the ultrasonic equipment is in use, also reducing the risk of aerosols and noise – if not interlocked, the equipment should be clearly labelled, warning

users not to put their hands in the device when it is activated;

- a means to control the detergent's concentration;
 - an automatic printer and data-logger (this can be integrated) that records:
 - time and date,
 - cycle type,
 - unique cycle number,
 - duration of cycle,
 - equipment serial number,
 - minimum/maximum temperatures,
 - a sensor recording ultrasonic activity,
 - electrical demand (in watts or amperes),
 - cycle failure indication;
 - a display indicator integral to the unit clearly displaying:
 - time and date,
 - elapsed cycle time,
 - maximum/minimum temperatures,
 - ultrasonic activity,
 - cycle failure indication,
 - lamp warning indicators;
 - lower-level fluid sensor/auto cut-off;
 - thermostatic control;
 - over-temperature sensor, with automatic cut-off and warning indication;
 - a cleaning cycle ideally identified by a unique cycle number.
- 10.22 Ultrasonic equipment should come with an easily-readable operating, maintenance and technical manual that includes:
- installation requirements;
 - suitable chemicals, for use;
 - degas requirements (prior to use);
 - optimum working temperatures;
 - cleaning instructions (stipulating suitable detergent) for the user;
 - safety instructions;

- explanation of warning indication (cycle failure etc);
- all maintenance requirements;
- monthly maintenance requirements or as per manufacturers' recommendations;
- yearly testing and validation requirements/ procedures;
- consumable parts list;
- spares components list incorporating identification numbers;
- make, model and serial number;
- lifting and handling requirements;
- staff training;
- appropriate PPE.
- Is steam sterilization (134–138°C for a minimum of three minutes) appropriate for the instruments?
- If another time/temperature range is recommended, can this be undertaken?
- Is training required? Will the manufacturer provide it?
- What commissioning and validation is required for the equipment? What are the ongoing costs?

Note

Difficult-to-clean serrated handles should be avoided; it should also be ensured that hinges are easy to clean.

Selecting instruments

10.23 When selecting new instruments, the following should be considered:

- For what purposes will the instruments be used – will the instruments selected be fit for this purpose?
- Is it compatible with other instruments in use?
- Is there an appropriate single-use device that would meet the requirements?
- If reusable, how easy will it be maintained?
- Does the instrument need dismantling before cleaning?
- Are there instructions from the manufacturer describing how this can be done?
- Does the instrument have a limited lifecycle specified by the manufacturer?
- What are the manufacturer's recommendations for cleaning and will they be achievable in practice?
- Will the instrument withstand automated washer-disinfector processes?
- What cleaning agents are recommended – do they comply with COSHH and health and safety requirements? Are these cleaning agents compatible with the washer-disinfector, ultrasonic cleaner and instruments already used in the practice?

Policy on new reusable instruments

10.24 Before being put into use, new dental instruments should be fully decontaminated.

10.25 Reusable dental instruments should be separated into:

- those that can withstand either processing in a washer-disinfector or ultrasonic cleaning; and
- those that will require manual cleaning (although practices should aim to phase in instruments that can be cleaned via automated processes).

10.26 Some instruments consisting of more than one component will need to be dismantled for cleaning. The manufacturer's instructions should always be followed.

10.27 Personal training records should show that:

- staff have been appropriately trained;
- staff are competent to decontaminate the reusable dental instruments presently in use; and
- training is updated for any new instruments introduced into the dental environment.

10.28 Items that cannot be immersed in water (for example, electrical and electronic equipment) should be cleaned in accordance with the manufacturer's instructions.

10.29 If recommendations include wiping with a detergent solution, then a clean non-linting cloth plus the recommended detergent solution (to wipe the instrument) should be used. This should be followed by wiping with a clean damp non-linting

cloth to remove residues. The instrument should be dried thoroughly using a clean non-linting cloth.

10.30 If disinfection with alcohol is advised, the advice given in paragraph 10.29 should be followed. While this procedure may be advised, it should be understood that alcohol may have the property of fixing certain contamination.

11 Decontamination equipment: general guidance on maintenance and testing

Maintenance and servicing

- 11.1 All decontamination equipment should be subjected to validation, testing, maintenance and servicing as recommended by the manufacturer/supplier. All records of these procedures should be retained for audit/inspection.
- 11.2 All equipment should also be periodically tested as advised in [Chapters 12–14](#). An unsatisfactory test result indicates that the decontamination equipment should not be used until the fault has been rectified.
- 11.3 Failure to perform these tasks or retain evidence of their performance may indicate non-compliance of the decontamination process. Alternative protocols of maintenance should be equal to, or exceed, the manufacturer's specification and must be justified.

Validation and testing

- 11.4 All pieces of decontamination equipment will need a protocol for validation at installation.
- 11.5 For steam sterilizers, the preferred protocol (option A) is as follows:
 - a. The Competent Person (Decontamination) or service engineer should test or validate the equipment.
 - b. The Competent Person (Decontamination) or service engineer should then submit the validation/service report to the Registered Manager in order to bring the equipment into service.
 - c. The Registered Manager should copy and forward the report to an Authorising Engineer (Decontamination).
 - d. If the Authorising Engineer (Decontamination) confirms the report, he/she will return it to the Registered Manager for record-keeping purposes.

Note

If the report is rejected by the Authorising Engineer (Decontamination), the Authorising Engineer should notify the Registered Manager as soon as practicable.

- 11.6 The second option (option B) for steam sterilizers – and the standard approach for washer-disinfectors and ultrasonic cleaners – is as follows:
 - a. The service engineer produces a service report containing a validation statement declaring that the equipment manufacturer can demonstrate that the product complies with the CE-marking process under the terms of the Medical Devices Regulations.
 - b. By this process, the contract between the Registered Manager, the equipment manufacturer and the service engineer acts as a form of validation.
- 11.7 This should be performed in full prior to equipment use, then periodically as advised in [Chapters 12–14](#).
- 11.8 The validation report provides auditable evidence of testing (see paragraph 11.5).
- 11.9 These protocols will require full implementation and all results need recording in a logbook dedicated to individual equipment. Standard logbooks summarising all required tests are available for most types of decontamination equipment. Manufacturers should be consulted on the contents of the logbook (see also Appendix 2).
- 11.10 If local or in-house documentation is used, its suitability should be discussed and agreed with the decontamination equipment manufacturer. In addition, where available, an Authorising Engineer (Decontamination) will also be able to advise.
- 11.11 Periodic inspections/testing logs will need to be signed by the Competent Person

(Decontamination) or service engineer and be countersigned by the Registered Manager.

11.12 Daily and weekly records should be signed by the User before equipment is returned for use. This signature acts as a “certification of fitness for use” based on information and advice from the manufacturer (often represented by the Competent Person (Decontamination) or service engineer). Lack of a User signature may well indicate non-compliance.

Note

The User is defined as the person designated by the Registered Manager to be responsible for the management of the decontamination equipment and process. For a dental practice, this would normally be dentists themselves.

11.13 The validation schedules for sterilizers outlined in paragraph 11.5 and [Chapter 12](#) are part of the **essential quality requirements**. However, in terms of testing schedules for washer-disinfectors and ultrasonic cleaners, manufacturers’ guidance should be sought. Note that the schedules outlined in Chapters [13](#) and [14](#) should be followed in the absence of manufacturers’ instructions.

Documentation

11.14 Documentation provides the only evidence of completed work. Absence of documentation for any work item will indicate omission of that item. It is important that all documentation relating to decontamination equipment is up-to-date and is retained locally for audit/inspection purposes.

11.15 The following documentation should be retained for the equipment and be readily/freely available at any time:

- specification;

- validation report, where the preferred option (option A) is selected – independently monitored by the Authorising Engineer (Decontamination). Where option B is followed, a service report (validation) signed by the service engineer or Competent Person (Decontamination) on behalf of the manufacturer’s agent;
- performance qualification details – loading patterns and required parameter values;
- logbook of periodic testing;
- logbook of plant history, component replacement etc;
- process log;
- training and competency records;
- documentation for Pressure Systems Safety Regulations 2000 including written scheme of examination and examination reports;
- list of all named designated responsible persons;
- other relevant documentation.

12 Installation, validation, maintenance and testing of sterilizers

Maintenance and servicing

12.1 The sterilizer should be maintained and serviced in accordance with the manufacturer's instructions.

Validation and testing

12.2 Validation is needed for new equipment at installation and annually thereafter. It will also be necessary to validate equipment after any major repairs have been carried out. Manufacturers' guidance on validation should be followed.

12.3 The following type-tests or works tests will be required.

Test	Type	Performed by	European Norm (EN) reference
Dynamic chamber pressure	B S N	Manufacturer	EN 13060
Air leakage	B S	Manufacturer	EN 13060
Empty chamber	B S N	Manufacturer	EN 13060
Solid load		Manufacturer	EN 13060
Non-wrapped	N S		
Single-wrapped	S		
Double-wrapped	B S		
Small porous items		Manufacturer	EN 13060
Single-wrapped	S		
Double-wrapped	S		
Small porous load		Manufacturer	EN 13060
Single-wrapped	S		
Double-wrapped	B S		
Full porous load		Manufacturer	EN 13060
Single-wrapped	S		
Double-wrapped	B S		
Hollow load	B S	Manufacturer	EN 13060
Solid load dryness		Manufacturer	EN 13060
Non-wrapped	S		
Single-wrapped	S		
Double-wrapped	B S		
Small porous items: dryness		Manufacturer	EN 13060
Single-wrapped	S		
Double-wrapped	S		

Test	Type	Performed by	European Norm (EN) reference
Small porous load: dryness		Manufacturer	EN 13060
Single-wrapped	S		
Double-wrapped	S		
Full porous load: dryness		Manufacturer	EN 13060
Single-wrapped	S		
Double-wrapped	B S		
Residual air	S N	Manufacturer	EN 13060
Microbiological test (optional)	B S N	Manufacturer	EN 13060

Note: Immediately after installation, the air leakage and empty chamber tests should be undertaken by the Competent Person (Decontamination) or service engineer.

12.4 Tests not defined in the referred Standards are further defined in [Chapter 15](#).

Periodic tests

12.5 The following testing protocol is recommended. Additional tests as defined by the manufacturer should also be performed.

Note

Users and operators (when delegated) should receive the appropriate training before carrying out any of these tests. This training should be documented on personal training records.

The Registered Manager should liaise with the equipment manufacturer with regard to training.

Test	Type	Performed by	Reference
DAILY			
Steam penetration	B S	User or, by delegation, Operator	MDA DB 2002(06)
Automatic control test	B N S	User or, by delegation, operator	Paragraphs 15.3–15.5
WEEKLY including daily tests plus:			
Air leakage	B S	User or, by delegation, Operator	MDA DB 2002(06)
Residual air test	S N	User or, by delegation, Operator	MDA DB 2002(06)
QUARTERLY (or to manufacturers' recommendations) including weekly tests plus:			
Thermometric tests	B N S	CP(D)/service engineer	MDA DB 9804
ANNUALLY including quarterly tests plus:			
Steam generator overheat cut-out test	B N S	CP(D)/service engineer	MDA DB 9804
Thermometric tests	B N S	CP(D)/service engineer	EN 13060
Small load			
Large load			
Dryness tests	B S	CP(D)/service engineer	EN 13060
Small load			
Large load			

13 Installation, validation, maintenance and testing of washer-disinfectors

Maintenance and servicing

13.1 The washer-disinfector should be maintained and serviced in accordance with the manufacturer's instructions.

necessary to validate equipment after any major repairs have been carried out. Manufacturers' guidance on validation should be followed; alternatively, the following protocol is suggested. (Tests not defined in the referred Standards are defined in [Chapter 15](#).)

Validation

13.2 Validation is needed for new equipment at installation and annually thereafter. It will also be

Test	Description	Performed by	Reference
Verification of calibration	The accuracy of indicating and recording instruments is checked against certificated source instruments	CP(D)/service engineer	BS EN ISO 15883:1 and BS EN ISO 15883:2
Automatic control test	The values of cycle time and temperature are noted at relevant stages of the cycle so that a fingerprint of the automatic cycle can be made.	CP(D)/service engineer	BS EN ISO 15883:1 and BS EN ISO 15883:2
Rinse-water quality test	Indicates acceptable values for all critical chemical purity parameters	CP(D)/service engineer	BS EN ISO 15883:1 and BS EN ISO 15883:2
Pipework	Ensures free-flowing drainage	CP(D)/service engineer	BS EN ISO 15883:1 and BS EN ISO 15883:2
Doors and door interlocks	Confirms safety to operator and exposure to complete cycle only	CP(D)/service engineer	BS EN ISO 15883:1 and BS EN ISO 15883:2
Fluid emission	Confirms door-seal prevents contamination to surroundings	CP(D)/service engineer	BS EN ISO 15883:1 and BS EN ISO 15883:2
Detergent dosing test	Confirms repeatable detergent addition	CP(D)/service engineer	BS EN ISO 15883:1 and BS EN ISO 15883:2
Cleaning efficacy test	Using an artificial soil to clean a worst-case load, chamber walls and load carriers to confirm the exposure to cleaning parameters is sufficient to remove soil	CP(D)/service engineer	BS EN ISO 15883:1 and BS EN ISO 15883:2
Thermometric test	Thermocouples are attached to worst-case load, chamber walls and load carriers to confirm that disinfection parameters are acceptable	CP(D)/service engineer	BS EN ISO 15883:1 and BS EN ISO 15883:2
Load carriers	Confirms mechanical alignment of all load carriers	CP(D)/service engineer	BS EN ISO 15883:1 and BS EN ISO 15883:2

Periodic tests

13.3 The following testing protocol is recommended. Additionally any additional tests defined by the manufacturer should also be performed.

Test	Description	Performed by	Reference
DAILY			
Remove and clean strainers and filters	Ensures filters and strainers are clean	User or, by delegation, Operator	BS EN ISO 15883:1 and BS EN ISO 15883:2
Cleaning efficacy	Visual examination of all load items	User or, by delegation, Operator	BS EN ISO 15883:1 and BS EN ISO 15883:2
WEEKLY including daily tests plus:			
Protein residue test	Confirms that cleaning process retains the capability of removing protein	User or, by delegation, Operator	BS EN ISO 15883:1 and BS EN ISO 15883:2
Safety checks	Check condition of door seal	User or, by delegation, Operator	Manufacturer
QUARTERLY (or to manufacturers' recommendations) including weekly tests plus:			
Safety checks	Check safe operation of doors and door interlocks	CP(D)/service engineer	Paragraphs 15.14–15.18
Automatic control test		CP(D)/service engineer	BS EN ISO 15883:1 and BS EN ISO 15883:2
Cleaning efficacy test		CP(D)/service engineer	BS EN ISO 15883:1 and BS EN ISO 15883:2
Chemical dosing	Confirm delivery of detergent (and any other additives) is repeatable and the machine reacts correctly to low levels of any additive	CP(D)/service engineer	BS EN ISO 15883:1 and BS EN ISO 15883:2
Thermometric disinfection test	Use of thermocouples on worst-case load to confirm disinfection parameters are acceptable	CP(D)/service engineer	BS EN ISO 15883:1 and BS EN ISO 15883:2
ANNUALLY including quarterly tests plus:			
Completion of all validation tests above		CP(D)/service engineer	BS EN ISO 15883:1 and BS EN ISO 15883:2

14 Installation, validation, maintenance and testing of ultrasonic cleaners

Maintenance and servicing

14.1 The ultrasonic cleaner/irrigator should be maintained and serviced in accordance with the manufacturer's instructions. However, in the absence of these instructions, the schedules outlined in this chapter should be followed.

Validation

14.2 Validation is needed for new equipment at installation and annually thereafter. It will also be necessary to validate equipment after any major repairs have been carried out. Manufacturers' guidance on validation should be followed; alternatively, the following protocol is suggested. (Tests not defined in the referred Standards are defined in [Chapter 15](#).)

Test	Description	Performed by	Reference
Verification of calibration	The accuracy of indicating and recording instruments is checked against certificated source instruments	CP(D)/service engineer	BS EN ISO 15883:1 and BS EN ISO 15883:2
Automatic control test	The values of cycle time and temperature are noted at relevant stages of the cycle so that a fingerprint of the automatic cycle can be made.	CP(D)/service engineer	Paragraphs 15.3–15.5
Drainage test (where applicable)	Ensures free-flowing drainage	CP(D)/service engineer	BS EN ISO 15883:1 and BS EN ISO 15883:2
Lid (ie door) interlock	Confirms safety to operator and exposure to complete cycle only	CP(D)/service engineer	BS EN ISO 15883:1 and BS EN ISO 15883:2
Fluid emission	Confirms door-seal prevents contamination to surroundings	CP(D)/service engineer	BS EN ISO 15883:1 and BS EN ISO 15883:2
Chemical dosing test (where automated)	Confirms repeatable detergent addition	CP(D)/service engineer	BS EN ISO 15883:1 and BS EN ISO 15883:2
Cleaning efficacy test	Using an artificial soil to clean a worst-case load, the exposure to ultrasonic activity for a sufficient time period is confirmed	CP(D)/service engineer	BS EN ISO 15883:1 and BS EN ISO 15883:2
Thermometric test (where machine also disinfects)	Thermocouples are attached to worst-case load to confirm that disinfection parameters are acceptable	CP(D)/service engineer	BS EN ISO 15883:1 and BS EN ISO 15883:2
Ultrasonic activity test	The use of aluminium foil within the cleaner tank indicates a uniform distribution of ultrasonic activity A wand meter may be used as long as points of measurement are compatible with the foil test and are fully recorded	CP(D)/service engineer	Paragraphs 15.6–15.13

Periodic tests

14.3 The following testing protocol is recommended. Additionally any additional tests defined by the manufacturer should also be performed.

Test	Description	Performed by	Reference
DAILY			
Remove and clean strainers and filters	Ensures filters and strainers are clean	User or, by delegation, Operator	Manufacturer
Drain machine at end of day/session	Ensures contaminated water is not stored in tank	User or, by delegation, Operator	Manufacturer
Cleaning efficacy	Visual examination of all load items	User or, by delegation, Operator	Manufacturer
WEEKLY including daily tests plus:			
Safety checks	Check condition of door-seal	User or, by delegation, Operator	Manufacturer Paragraphs 15.14–15.18
Protein residue test	Confirms that cleaning process retains the capability of removing protein	User or, by delegation, Operator	BS EN ISO 15883:1
QUARTERLY (or to manufacturers' recommendations) including weekly tests plus:			
Automatic control test		CP(D)/service engineer	BS EN ISO 15883:1
Verification of calibration		CP(D)/service engineer	BS EN ISO 15883:1
Cleaning efficacy test		CP(D)/service engineer	BS EN ISO 15883:1
Ultrasonic activity test		CP(D)/service engineer	BS EN ISO 15883:1
ANNUALLY including quarterly tests plus:			
Completion of all validation tests above		CP(D)/service engineer	As above

Note

For cleaning efficacy tests and protein residue tests, where the cycle does not have a rinse stage, items should be rinsed as a normal procedure before these tests are carried out, otherwise the tests could return false positives.

15 Additional information on test procedures (in addition to those provided in the Standards)

- 15.1 Most test procedures are defined in the referenced Standards shown in the testing protocols in [Chapters 12–14](#). Unless these tests are to be performed by suitably-qualified and certificated practice staff (see Choice Framework for local Policy and Procedures 01-01 Part A for further guidance on training and certification), it will not be necessary for the practice to possess copies of these Standards. It will, however, be necessary that any contracted test performance include reference to the requirements of these Standards.
- 15.2 The following tests are additional to those shown in the referred Standards. These additional test procedures are compliant with EN Standards and should be applied where necessary and if relevant to the type of decontamination equipment being used.
- during the hold period, the disinfection/cleaning/sterilizing temperatures are within an appropriate temperature band;
 - the time for which the temperatures above are maintained is not less than that previously established either by the manufacturer or validation tests as necessary;
 - the door cannot be opened until the cycle is complete (it is not advisable to attempt to open the door in case the safety devices are malfunctioning – this test should only be performed by someone fully trained to do so);
 - the person conducting the test does not observe any mechanical or other anomaly.

Automatic control test

- 15.3 This test (see list of tests in [Chapters 12–14](#)) is designed to show that the operating cycle functions correctly as shown by the values of the cycle variables indicated and/or recorded by the instruments fitted to the decontamination equipment.

Method

- 15.4 Place the test load (as defined in BS EN 13060) appropriate to the cycle to be tested and the load to be processed in the chamber. Select and start the cycle to be tested. If a process-data recording is not made by the machine, the elapsed time, chamber temperatures and pressures – at all significant stages of the cycle – should be observed and noted.
- 15.5 At the approximate mid-point of the hold time (disinfection, cleaning, sterilizing), note the elapsed time and indicated critical parameters. The test will be considered satisfactory if the following requirements are met:
- a visual display of “cycle complete” occurs;
 - during the whole of the cycle the values of the cycle parameters as indicated or shown on the process-data record are within the limits established as giving satisfactory results either by the manufacturer or the validation tests;

Ultrasonic activity test

- 15.6 The ultrasonic activity can be investigated by the erosion pattern created on aluminium foil exposed in the tank for a short period. This activity may not be uniform throughout the tank. Validation tests will determine the pattern variation at defined positions and the time required to produce this pattern.
- 15.7 The exposure time will depend upon the type of foil used. (Standard test foil is now available to maximise repeatability.)
- 15.8 The following equipment will be required:
- aluminium foil provided for ultrasonic cleaner testing;
 - adhesive tape (for example autoclave indicator tape or masking tape);
 - a watch or clock with a second hand;
 - a rule or tape measure.

Method

- 15.9 The following method should be used:
- Cut strips of aluminium foil in lengths 120 mm longer than the bath is deep. Roll up one end of the foil so that the foil is now as long as the bath is deep.
 - Ensure that:
 - the water in the tank is at the required level;

- the required amount of any chemical additive specified by the manufacturer has been added; and
- the water in the tank is at the specified operating temperature.
- Carry out the manufacturer's recommended start-up procedure. This will normally include a period of operation to eliminate dissolved gases from the solution in the bath (the degassing procedure).
- Using strips of adhesive tape across the top of the bath, suspend nine strips of the prepared foil in the bath in a 3 × 3 grid. Ensure that the rolled bottom end of each foil strip is no more than 10 mm above, but not touching, the bottom of the bath.
- Operate the bath for the predetermined exposure time. This varies typically between 30 seconds and 10 minutes depending on the power rating of the ultrasonic transducers.
- Remove the strips from the bath, blot-dry and examine. The strips can be filed conveniently by sticking them to a sheet of plain paper using a transparent adhesive tape.
- Drain the bath and clean to remove debris of eroded aluminium foil.

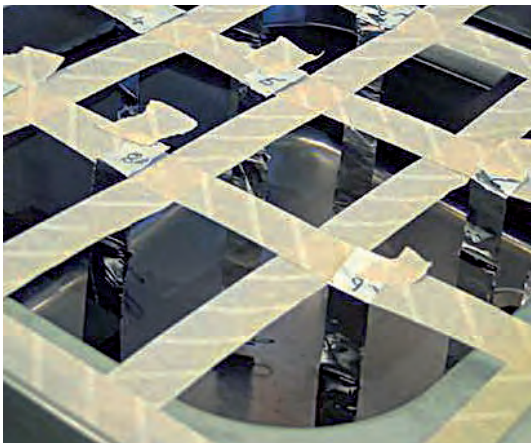

Reproduced by kind permission of the Scottish Dental Clinical Effectiveness Programme

Results and interpretation

- 15.10 When the foil strips are inspected, the areas that show maximum erosion should be at similar positions on all nine foils and each should be eroded to a similar extent.
- 15.11 On re-testing the extent of erosion, the erosion pattern should remain consistent. If the zones of erosion are markedly different on the nine foils, it indicates poor uniformity of cleaning. Poor uniformity of cleaning might be due to failure of one or more of the transducers that produce the ultrasonic vibration in the base of the bath.
- 15.12 A significant change between tests indicates a deterioration or failure in the transducers. If there is no erosion, this indicates complete failure. In the event of any of these findings, withdraw the ultrasonic cleaner from use and send it for repair or replace it.

Wand meters

- 15.13 Ultrasonic energy meters are now available to monitor efficiency and operating frequency of ultrasonic baths. They are much quicker and more convenient than the classic foil ablation test but should be used with care. Precise positioning of the wand will need to be noted in order to make the test repeatable.

Safety checks

Weekly checks

- 15.14 The User should check the following before proceeding:
- Examine the door seals.
 - Check the security and performance of the door safety devices.
- 15.15 Where the equipment possesses a pressure vessel, the following checks should be performed:
- Ensure safety valves and other pressure-limiting devices are free to operate.
 - Carry out any other checks required by the Competent Person (Pressure Systems) or the written scheme of examination.

Yearly checks

- 15.16 The Competent Person (Decontamination) or service engineer should conduct a series of safety checks before proceeding. Advice on the yearly programme of safety checks may be sought from the Authorising Engineer (Decontamination).
- 15.17 The validation checks and tests may be used as a basis for yearly safety checks, paying particular attention to those factors affecting safety and particularly those which may have changed since the previous annual safety check or validation test.
- 15.18 The Competent Person (Decontamination)/service engineer should ensure verification of the adequacy and safe connection of engineering services.

16 Approach and protocol for manual cleaning

Note

The use of manual cleaning presents particular problems. Because the process is not automatic, it is not possible to fully validate the process. Manual cleaning is thus not the preferred method of cleaning. Where possible, manual cleaning should be replaced with automated cleaning. However, where manual cleaning is necessary (for example, as advised by the manufacturer) and where the practice is operating under the **essential quality requirements**, the critical parameters should be controlled as much as possible to reduce the variability in cleaning performance. The following advice aims to enable this control as much as possible.

- 16.1 A dirty-to-clean workflow should be maintained throughout the cleaning procedure. Two sinks or bowls should be provided – one for manual cleaning and one for rinsing. In addition, separate setting-down areas should be used for dirty instruments and for clean instruments.
- 16.2 If lack of space means that a setting-down area has to be used for both dirty and clean instruments at different times during the decontamination process, the surface should be thoroughly cleaned between stages using a water–detergent solution to minimise the risks of cross-contamination.
- 16.3 Always use detergents specifically formulated for manual cleaning of instruments.

Important

Do not use chlorhexidine handscrub (for example Hibiscrub), washing-up liquid, cleaning creams or soap. Chlorhexidine in particular makes proteins stick to steel.

Cleaning procedure for dental instruments

- a. Measure the volume of water and detergent to achieve the concentration specified by the detergent manufacturer. A line painted on the sink is useful to indicate the required volume of water. The detergent should be designed for the manual cleaning of dental instruments.
- b. Using a mercury-free thermometer, monitor the temperature of the water throughout the cleaning procedure to ensure the temperature of the water is 45°C or lower (a higher temperature will coagulate protein and inhibit its removal). The temperature of the fluid should be as recommended by the detergent manufacturer.
- c. Where manufacturers' instructions permit, fully submerge items to be cleaned in the detergent solution.
- d. Scrub instruments using long-handled brushes with soft plastic bristles. To minimise aerosol risk, fully immerse the instruments in the solution and keep under water during the cleaning process.
- e. Following cleaning, drain the water, avoiding splashing. If the water is heavily soiled, repeat the cleaning procedure.
- f. Brushes should be single use. Where they are reusable, after each use, the brushes should be washed in hot water using the manufacturer's recommended detergent, in order to remove visible soil, and be stored dry and head up. Or dispose of brushes if they are single-use. Reusable brushes should be replaced at the manufacturer's recommended interval or more frequently if the brush is seen to have significantly deteriorated.
- g. Carry out a final rinse in the clean sink using satisfactory potable water (see [paragraphs 3.14](#), and [17.8–17.10](#)), or RO water or distilled water only.
- h. After rinsing, drain and dry if instruments are to be wrapped.

Protocol for the manual cleaning of dental instruments

Immersion method

All personnel involved in the decontamination of dental instruments should be trained in the content and application of this protocol and associated guidance.

To minimise the risk to personnel undertaking manual cleaning, the splashing and creation of aerosols **should be avoided** at all times.

Remember: Maintaining a dirty-to-clean workflow procedure will assist in the cleaning process.

- Wash hands.
- Wear personal protective clothing (PPE).
- Prepare sinks, equipment and setting-down areas.
- Dismantle and open the instruments, as applicable, ready for immersion.
- Fill the clean sink (NOT wash-hand basin) with the appropriate amount of water and detergent (specified for the purpose). Note: ensure correct temperature as recommended by the detergent manufacturer is maintained.
- Fully immerse the instruments in the solution and keep under water during the cleaning process to prevent aerosols.
- Agitate/scrub the instruments using long-handled brushes with soft plastic bristles.
- Drain any excess cleaning solution prior to rinsing.
- Rinse in a second sink with satisfactory potable, distilled or RO water.
- After rinsing, drain and dry if instruments are to be wrapped.
- Visually inspect all items under an illuminated magnifier ensuring they are clean, functional and in good condition.
- Lubricate any relevant items prior to sterilization with a non-oil-based lubricant.
- Dispose of cleaning materials safely in accordance with local policy.
- Replace cleaning solution and the rinse-water after each use.
- Complete any relevant documentation.

17 Steam and water quality

- 17.1 For the purposes of this document, either one of the following types of water is considered suitable: sterile water for irrigation; distilled water; reverse osmosis water or suitable potable water (see [paragraph 3.14](#)).

Steam

- 17.2 Decontamination within a dental decontamination facility should ensure that the quality and safety of the instruments are not affected by the decontamination process itself.
- 17.3 Factors affecting the quality of the steam, and thus the safety of the instruments, include the following: material of chamber construction; quality of feed-water; conditions of storage of feed-water; period between changes of feed-water.

Quality of input water

- 17.4 The quality of input water for benchtop sterilizers is defined in Annex C of BS EN 13060. Care should be taken to observe use-by dates. Any water unused or left in opened containers at the end of the day should be discarded.

Conditions of storage and frequency of change

- 17.5 Feed-water may be stored in a reservoir in the machine and can be either reused or used once only. While both are acceptable, there is some advantage in using the water once only in that there is no build-up of contamination within the reservoir.
- 17.6 However, even high-quality water is subject to microbial contamination. For this reason – irrespective of whether the water is used once only – the reservoir should be emptied at such a frequency as to eliminate microbiological build-up.
- 17.7 Current recommendations are for the reservoir to be drained down and cleaned at the end of each working day or daily shift. Water should not be left in the machine overnight.

Water

The configuration of water supply networks now means the water sources from which supplies are drawn may vary considerably in many parts of England, such that hard water can appear in normally soft water areas. The local water supplier (undertaker) will be able to advise on local supply quality and potential changes.

Cleaning

- 17.8 Cleaning and rinsing (either manual or automated) can be performed with potable water as long as the water hardness is low enough and other aspects of water quality are satisfactory. This should be confirmed with the manufacturer of the washer-disinfector and detergent.
- 17.9 Practices should check with the detergent manufacturer that level of hardness is compatible with the detergent used and for its use in a washer-disinfector. If the input water has a hardness that is not compatible, water softening is expressly advised. An ongoing knowledge of the hardness of the incoming water feed is therefore necessary.

Final rinsing

- 17.10 The final rinsing of instruments – for example, those washed manually, in an ultrasonic bath or in a washer-disinfector – should be carried out using satisfactory potable water, or RO water or distilled water.

Detergents

- 17.11 The efficacy of cleaning will depend on the relationship between potable water quality and detergent performance. The detergent should be chosen for its cleaning efficacy and its compatibility with the water quality.

18 The use of lubricants

18.1 Lubricants, usually in aerosol form, are often used during the decontamination and preparation process. This is often required by the manufacturer in order to lengthen the working life of some instruments. Such instructions should be followed. Any doubts about the relevance of these instructions should be checked and confirmed in writing by the manufacturer.

18.2 It should be noted that using lubricants will inevitably introduce oils into a process designed to remove contamination. Where water is reused in the sterilizer, this contamination may build up within the reservoir and the sterilizer chamber.

However, this effect will be limited if guidance given in this document requiring that water be changed at least once per day is carefully applied.

18.3 There is a limited conflict between decontamination and the use of lubricant. If lubrication is practised in accordance with manufacturers' instructions, the consequence of this recontamination should be assessed. This assessment will require consultation with the equipment manufacturer or service agent whom should be asked to approve the choice of lubricant used.

19 Hot and cold water systems and dental unit water lines

19.1 Registered Managers of dental practices have an overriding general duty of care under the Health and Safety at Work etc Act 1974. Therefore, they should ensure that the water supply, storage and distribution services should comply with the best practice guidance given in:

- the Health & Safety Commission's 'Legionnaires' disease – the control of *Legionella* bacteria in water systems. Approved Code of Practice & guidance' (also known as L8); and
- Health Technical Memorandum 04-01 – 'The control of *Legionella*, hygiene, "safe" hot water, cold water and drinking water systems'.

The Approved Code of Practice L8 has a special legal status. Health and safety inspectors seek to secure compliance with the law and may refer to L8 as an illustration of good practice.

Compliance with Health Technical Memorandum 04-01 and this guidance document will satisfy L8.

19.2 All premises are required to have a **written scheme** and a *Legionella* **risk assessment** for controlling any identified risks in accordance with the Health and Safety Commission's (2000) Approved Code of Practice L8:

- A **risk assessment** for the water services will be necessary to identify potential problems in the system (for example, excess storage capacity, temperature distribution problems, low water usage, inappropriate materials etc). The risk assessment should be carried out by a competent person.
- These schemes should be written by experienced and competent people.
- The Registered Manager should ensure that an operational plan is in place for each site under his/her control. This document should comprise:
 - up-to-date as-fitted drawings, schematic diagrams and descriptions of all the supply,

storage and distribution systems within those premises;

As-fitted drawings can be obtained from third parties such as architects.

- step-by-step instructions to operate, maintain, control and shut down the water supply, storage and distribution systems within those premises;
- a schedule of possible emergency incidents causing loss of the water supply from the water undertaker. Each item in the emergency incident schedule should include guidance on operational procedures to re-establish a stable wholesome water supply.

19.3 The Registered Manager should implement a programme of staff training to ensure that those appointed to devise strategies and carry out control measures are appropriately informed, instructed and trained, and should be assessed as to their competency. It is also essential that they have an overall appreciation of the practices affecting water hygiene and safety, and that they can interpret the available guidance and perform their tasks in a safe and technically competent manner.

Safe hot water temperature

- 19.4 To reduce the risk of scalding, thermostatic mixing devices should be installed where applicable. A risk assessment will be necessary to establish the need and type of device to be installed.
- 19.5 Routine checks are essential to ensure continued satisfactory operation.

Utilisation

19.6 One of the critical factors affecting the quality of water within hot and cold water distribution systems is the extent of utilisation. The Registered Manager needs to ensure that there is good liaison between staff members in the dental practice to ensure that the water services are sufficiently used.

- 19.7 L8 recommends that, for sporadically used taps, flushing is carried out once a week. The procedure for such practice should be fully documented and covered by written instructions.

Flushing dental unit water lines (DUWLs)

- 19.8 For procedures on flushing DUWLs between treatment sessions and at the beginning/end of each working day, see [paragraphs 6.84–6.86](#).

Decommissioning of DUWLs

- 19.9 Follow the manufacturer's guidance for the temporary decommissioning of DUWLs.
- 19.10 In the absence of manufacturers' guidance, DUWLs should be flushed, drained and left disconnected during any temporary closure of the treatment room. If this is not practicable, they should be flushed on a weekly basis as per the guidance above.
- 19.11 Self-contained water bottles (bottled water systems) should be removed, flushed with distilled or RO water and left open to the air for drying. They should then be stored inverted to prevent contamination during the temporary closure.

Recommissioning of DUWLs

- 19.12 In the absence of manufacturers' guidance, flush the DUWL for at least three minutes, disinfect the DUWL with a suitable disinfectant (as recommended by the manufacturer for routine disinfection of the DUWL), then flush for a further three minutes.
- 19.13 Where in-line filters are used, these will require treatment using a cleansing solution that has been recommended by the manufacturer. This step should be performed after first flushing the DUWL.

Note

Care should be taken to minimise the occurrence of splashing and aerosol formation.

- 19.14 If DUWLs have disposable filters, they should be replaced.
- 19.15 Self-contained water bottles (bottled water systems) should be flushed with distilled or RO water. Where visual contamination is present, flushing with a suitable disinfectant followed by thorough washing is necessary. The manufacturer's

instructions will specify which disinfectant to use. In instances where visual contamination is routinely detected, it will be necessary to decrease the interval between flushing operations. If good practice is followed, practices should not routinely detect evidence of visual contamination.

Note

The self-contained water supplies used for dental care systems should be distilled or RO water (see [Chapter 17](#)).

- 19.16 As part of the recommissioning, dental equipment requiring protection against backflow should have the anti-retraction valves (incorporated on handpieces or waterlines) checked by the responsible person. They should ensure they are suitably decontaminated, refitted correctly and are operating in the correct manner. Examples of dental equipment requiring backflow protection are:
- dental spittoons;
 - three-in-one syringes;
 - ultrasonic scalers;
 - wet-line suction apparatus; and
 - self-filling automatic radiographic processors (where still used).
- 19.17 Adherence to the equipment manufacturer's recommended cleaning procedures, including use of the manufacturer's recommended chemicals, is a requirement for medical devices such as those listed above.

Maintenance policy

- 19.18 The Registered Manager is ultimately responsible for the provision of a wholesome water supply in the premises under his/her authority.

Contract maintenance

- 19.19 When selecting subcontractors, particularly in relation to the control of *Legionella*, their competence should be established beforehand (for example, companies/individuals who are members of the Legionella Control Association).

Emergency action

- 19.20 Contingency plans should be available in the event of the following:

- a. A power failure:
 - This may result in a failure to maintain temperature in the hot water system.
 - If the dental practice produces its own distilled water, this will restrict the amount of distilled water that can be produced in a set time period.
- b. A mains-water failure that could last beyond the period for which storage capacity has been designed. This:
 - may result in the temporary cessation of the production of RO water;
 - may require the temporary cessation of sterile supply activities;
 - may result in hygiene issues for patient and staff WCs/washrooms.

The emergency action to be taken during an outbreak of healthcare-associated legionellosis is covered in Health Technical Memorandum 04-01 Part B Appendix 1.

Documentation

- 19.21 It is essential to have comprehensive operational manuals for all items of plant; they should include requirements for servicing, maintenance tasks and frequencies of inspection.
- 19.22 This information should be kept together with all commissioning data.

As-fitted drawings

- 19.23 The availability of accurate as-fitted drawings is essential for the safe operation of hot and cold water service systems. The drawings are necessary to perform the temperature control checks on the systems and will assist in identifying any potential problems with poor hot water circulation and cold water dead-legs where flow to sporadically-used outlets can be low. Such information should identify all key components in the installations, for example water meters, storage tanks (filtration equipment, where fitted), calorifiers and the location of isolating valves in the systems. As-fitted drawings can be obtained from third parties such as architects.
- 19.24 In addition to drawings, there should be comprehensive schedules of outlets, lists of sentinel

taps (outlets), other outlets to be tested annually and other components in the system.

Note

The information required above could be compiled by the Competent Person employed to produce the written scheme, since much of the information is an integral part of the written scheme itself.

Record-keeping

- 19.25 The User should ensure that an accurate record of all assets relating to the hot and cold water distribution systems is set up and regularly maintained.
- 19.26 The User should also ensure that records of all maintenance, inspection and testing activities are kept up-to-date and properly stored. Records should be kept for at least five years. As a minimum, the following items should be recorded:
- the names and positions of those responsible for performing the various tasks under the written scheme;
 - a *Legionella* risk assessment and a written scheme of actions and control measures;
 - details of precautionary measures that have been carried out, including sufficient detail to identify that the work was completed correctly and when the work was carried out.
- 19.27 Planned preventive maintenance will help to ensure that systems perform correctly, and an essential element of this process is the maintenance of accurate records.
- 19.28 Maintenance records should include the following:
- details of remedial work required and work carried out;
 - details of cleaning and disinfection procedures;
 - results of any chemical or microbiological analyses of water.
- 19.29 When alterations to equipment or systems are implemented, any drawings kept with the records should be updated to reflect the modifications carried out.
- 19.30 The asset register should be designed to provide the following information:
- an inventory of equipment;
 - a basis for identifying equipment details;

- a basis for recording the maintenance requirements;
- a basis for recording and accessing information associated with disinfection and maintenance.

19.31 When completing records, it is essential that the individual concerned signs and dates the entries, and that there is an audit trail in place.

Water supply hygiene

19.32 After any installation work, all piping, fittings and associated services used for the conveyance of water for domestic purposes must be disinfected before being brought into use. The method generally used for disinfection is chlorination. Disinfection using chlorine should be carried out in accordance with BS EN 806-2:2005, BS EN 806-3:2006 and BS 8558:2011 (see also Health Technical Memorandum 04-01 Part A Chapter 17) and under the direct supervision of a nominated person.

19.33 Despite disinfection of systems, some outbreaks of disease related to treated water supplies still occur. To reduce the risk of such outbreaks, the design should eliminate:

- direct contact with the internal parts of water pipes and structures by people, animals or birds (for example, ensure covers are in place on storage tanks/cisterns);
- backflow (back-siphonage) of contaminated water into systems conveying potable water (mains and storage structures).

Water treatment

19.34 In a properly installed and commissioned hot water system, it should be possible to maintain a temperature of at least 55°C at the furthest draw-off point in the circulating system, and 50°C in the circulating system's return connection to the calorifier.

19.35 In older premises, however, this may not be possible, and in the case of cold water systems it is not always possible or practicable to maintain water temperature below 20°C because of utilisation and complexity. In addition, therefore, it may be necessary to apply a residual biocidal water treatment that has been shown to destroy and remove biofilm. Information on these techniques, which include chlorine dioxide and copper and silver ionisation, can be found in Health Technical Memorandum 04-01 Part B.

Note

In addition to residual biocidal techniques, there are other manufacturer-specified treatments that are developed for use on DUWLs and other associated dental equipment. Refer to the manufacturer's instructions for their correct use.

19.36 Where automatic equipment is used for disinfection, it should indicate any change in the amount or concentration of material injected into the water so that immediate action can be taken.

19.37 Continuous dosing with appropriate biocides that have proven efficacy should be considered during construction to prevent the accumulation of biofilm. A regular flushing programme for all outlets should also be implemented.

19.38 The continuous chlorination of hot and cold water service systems to control the growth of *Legionella* is not generally recommended. Advice on the use of biocides should be sought from the person advising the practice on *Legionella*.

19.39 In defining their responsibilities, service providers should be asked to advise on test methods and anticipated concentrations of residual chemicals within the system. (See also Chapter 3 of Health Technical Memorandum 04-01 Part A for more guidance on water treatment regimens.)

Purging the systems

19.40 Where chemical treatment is introduced, it is essential to ensure that all parts of the system are purged so that adequate concentrations are achieved.

19.41 As temperature monitoring is performed on sentinel and representative outlets on a rolling basis only, additional draw-off will be required at all points on a regular basis.

Ozone and ultraviolet treatment

19.42 Whereas treatments such as chlorine dioxide and copper and silver ionisation are intended to be dispersive (that is, they result in a residual agent within the system), ozone and ultraviolet are intended to be effective close to the point of application. They are not, therefore, necessarily effective in hot and cold water service systems (see Chapter 15 of Health Technical Memorandum 04-01 Part A).

Metal contamination

19.43 See Health Technical Memorandum 04-01 Part A Chapter 6.

Filtration

19.44 It is essential for filter cartridge elements to be changed at appropriate intervals in accordance with the manufacturer's recommendations, taking into account local conditions.

19.45 Filter membranes should also be chemically cleaned or replaced at the recommended periods, and care must be taken to ensure that the "vessel" or "housing" containing the filter assembly is also disinfected appropriately during filter or membrane maintenance.

Water storage

19.46 For general information on water storage, see Health Technical Memorandum 04-01 Part A (paragraphs 7.1–7.2) and Health Technical Memorandum 04-01 Part B (paragraphs 7.54–7.61).

Cold water distribution system

19.47 The design and installation of the cold water distribution system should comply with the Water Supply (Water Fittings) Regulations 1999 and relevant parts of BS EN 806-2:2005, BS EN 806-3:2006 and BS 8558:2011. (See Chapter 8 of Health Technical Memorandum 04-01 Part A for further information.)

19.48 The control of water temperature in the cold water service will essentially rely on good insulation and water turnover. Cold water services should be sized to provide sufficient flow and should be insulated and kept away from areas where they are prone to thermal gains (this also applies to water supplies for spittoons). Stagnation must be avoided. Special attention should be given to the maintenance and monitoring of these systems.

19.49 Schematic drawings of the system with numbered and labelled valves will reduce confusion and save time in trying to identify appropriate isolating valves and other system components.

19.50 Checks and actions should be carried out to show that:

- the system components show no sign of leakage or corrosion;
- the system insulation is in good condition;

- the system filters have been changed and/or cleaned in accordance with manufacturer's recommendations. Strainers should be checked and cleaned regularly;
- all isolating valves have periodically been worked through their full range of travel;
- every water outlet complies with the backflow protection requirements of the Water Supply (Water Fittings) Regulations 1999.

Drinking water

19.51 If separate drinking water supplies are provided, reference should be made to Health Technical Memorandum 04-01 Part A (paragraphs 8.13 and 8.14).

Hot water storage and distribution

19.52 Hot water services should be designed and installed in accordance with the Water Supply (Water Fittings) Regulations 1999 and relevant parts of BS EN 806-2:2005, BS EN 806-3:2006 and BS 8558:2011. The hot water system may be of either the vented or the unvented type. (See Health Technical Memorandum 04-01 Part A Chapter 9 for further information.)

19.53 To control possible colonisation by *Legionella*, it is essential to maintain the temperature within the hot water circulating system. To some extent, if properly maintained, the calorifier/water heater will provide a form of barrier to *Legionella* and other water-borne organisms. The minimum flow temperature of water leaving the calorifier/water heater should be 60°C at all times and 55°C at the supply to the furthestmost draw-off point in the circulating system.

Notes

A minimum of 55°C may be required for the operation of suitable mixing devices to provide "safe" hot water at the upper limit of the recommended range.

In large non-recirculating systems, the minimum of 55°C should be maintained by electric trace-heating.

19.54 The minimum water temperature at the connection of the return to the calorifier/water heater should be 50°C. To achieve the required circulating temperatures, it will be necessary to maintain the balance of flows to individual pipe branches and draw-off points.

- 19.55 Calorifiers (where fitted) should be subjected to regular procedures that include the following:
- cleaning and maintenance;
 - quarterly draining to minimise the accumulation of sludge. This may be extended to annual draining if, during inspection, it is found that there is little accumulation of debris;
 - whenever dismantled for statutory inspection, or every year in the case of indirect calorifiers, calorifiers should be thoroughly cleaned to remove sludge, loose debris and scale;
 - whenever a calorifier is taken out of service, it should be refilled, drained, refilled again and the entire contents brought up to, and held at, the nominal operating temperature of 60°C for at least an hour.

See also Health Technical Memorandum 04-01 Part B paragraphs 7.74–7.76 for further advice on calorifiers.

Instantaneous water heaters for single or multi-point outlets

- 19.56 The general principles and limitations of instantaneous water heaters are given in the relevant parts of BS EN 806-2:2005, BS EN 806-3:2006 and BS 8558:2011. In essence:
- the flow rate is limited and is dependent upon the heater's hot water power rating;
 - where restricted rates of delivery are acceptable, the heater can deliver continuous hot water without requiring time to reheat;
 - they are susceptible to scale formation in hard water areas, where they will require frequent maintenance;
 - this form of hot water heating should only be considered for smaller premises or where it is not economically viable to run hot water distribution to a remote outlet.

Safe hot water delivery devices

- 19.57 Appropriate types of thermostatic mixing device are specified in Health Technical Memorandum 04-01 Part A Table 4.
- 19.58 It is essential to check the temperature settings and operation of all water mixing devices regularly (preferably every six months, provided that there is no "drift" in excess of 1°C). Other maintenance

should be strictly in accordance with the manufacturer's instructions.

- 19.59 Local water quality will influence the maintenance frequency for any installation. (A relatively small piece of debris may restrict the operation of the temperature control and fail-safe mechanisms.)
- 19.60 The recommendations regarding safe water temperature apply to all areas to which patients and visitors have free access.

Materials of construction

- 19.61 Systems should comply with the requirements of the Water Supply (Water Fittings) Regulations 1999. Materials used in contact with water that is for drinking etc should comply with BS 6920-1: 2000 and be listed in the latest edition of the 'Water Fittings and Materials Directory' published by WRAS.

Temperature control regimen

- 19.62 Temperature control regimen is the preferred strategy to maintain systems free from *Legionella* and other water-borne organisms. This will require monitoring on a regular basis. The test frequencies are listed below in Table 1.

Point-of-use filtration

- 19.63 Point-of-use filters must be changed in accordance with manufacturers' recommendations, typically at least once a month. When changing filters, it is recommended that water-quality sampling takes place at outlets identified as sentinel points before refitting a replacement filter. Except where taking samples as above, once point-of-use filtration has been introduced, taps or showers must not be used without a filter in place.
- 19.64 Where point-of-use filters are no longer required, the outlet and associated pipework must be disinfected to remove any accumulated biofilm before the system is returned to service (see also Health Technical Memorandum 04-01 Part A paragraph 5.16).

Summary checklist

- 19.65 A summary checklist for hot and cold water services showing recommended frequency of activity is given in Table 2.

The checks/tasks outlined in Tables 1 and 2 could be carried out by trained user or contracted-out to a third party.

Table 1 Tests for temperature performance

Frequency	Check	Cold water	Hot water	Notes
Monthly	† Sentinel outlets	The water temperature should equilibrate below 20°C after draw-off for 2 minutes ^{1,2}	The water temperature should equilibrate to at least 50°C after draw-off for 1 minute ³	These measurements are applicable to non-mixed outlets only
Monthly	Inlets to sentinel TMVs	Temperatures as above	Temperatures as above	Measurements can be made by means of surface temperature probes
Monthly	Water leaving and returning to calorifier			Also to be monitored continuously by BMS
6-monthly	In-coming cold water at inlet to building – in the winter and in the summer	The water should be below 20°C ²		Also to be continuously monitored by BMS
Annually	‡ Representative outlets	The water temperature should equilibrate below 20°C after draw-off for 2 minutes ^{1,2}	The water temperature should equilibrate to at least 50°C after draw-off for 1 minute ³	

Notes:

† Sentinel outlets are normally those that – on a hot water service – are the first and last outlets on a recirculating system. On cold water systems (or non-recirculating hot water systems), they are the closest and furthest from the storage tank (or water heater). The choice of sentinel taps should also include other outlets that are considered to represent a particular risk, for example those installed in accommodation in which particularly susceptible patients are treated, or others identified in the risk assessment and temperature mapping exercise as having the least satisfactory temperature performance.

‡ Representative outlets include conventional and mixed-temperature taps; 20% of the total number installed throughout the premises would be tested annually on a rotational basis: that is, all taps checked every five years.

1. The Health & Safety Commission's (2000) Approved Code of Practice L8 permits a period of two minutes to achieve an equilibrium temperature below 20°C. Achieving this minimum requirement would be indicative of an exceptionally underutilised water system. (At a typical flow to a wash-hand basin of 4.5 L/m, 2 minutes to achieve temperature would indicate a 50 m dead-leg of 15 mm pipe.)
2. The Water Supply (Water Quality) Regulations 2000 permit water undertakers to supply water to premises at temperatures up to 25°C. In practice, the water temperature is likely to be below this maximum value, typically below 10°C in winter and 20°C in summer. If, during prolonged periods of high environmental temperature, the water temperature starts to exceed 20°C, the water undertaker should be asked to see whether remedial action could be undertaken. Within the curtilage of the premises, the aim should be to ensure that the temperature difference between the in-coming supply and most distal parts of the distribution system is below 2°C.
3. The Health & Safety Commission's (2000) Approved Code of Practice L8 permits a period of 1 minute to achieve an equilibrium temperature of 50°C. A minimum of 55°C may be required for the operation of suitable mixing devices required to provide "safe" hot water at the upper limit of the recommended range. Hot water at 55°C is required in many cases for reasons of food hygiene or decontamination requirements, for example in kitchens and sluice rooms etc. In a properly balanced hot water circulating system, with the circulation taken close to the draw-off point, achieving temperature should be virtually instantaneous. (At a typical flow to a wash-hand basin of 4.5 L/m, 1 minute to achieve temperature would indicate a 25 m dead-leg of 15 mm pipe.)

Table 2 Summary checklist for hot and cold water services

Service	Task*	Frequency
Hot water services	Arrange for samples to be taken from hot water calorifiers/ water heaters in order to note condition of drain water	Annually
	Check temperatures in flow and return at calorifiers/water heaters	Monthly ⁴
	Check water temperature after draw-off from outlets for 1 minute to ensure that 50°C has been achieved in sentinel outlets ^{1,2,5}	Monthly ⁴
	Visually check internal surfaces of calorifiers/water heaters for scale and sludge. ⁵ Check representative taps for temperature as above on a rotational basis	Annually
	Manual check to confirm secondary hot water recirculation pumps are operating effectively	Monthly
Cold water services	Check tank water temperature remote from in-coming ball valve and mains temperatures. Note maximum temperatures recorded by fixed max/min thermometers, where fitted	6-monthly ⁴
	Check temperature in sentinel outlets after draw-off for 2 minutes to establish that it is below 20°C ^{2,3}	Monthly
	Visually inspect cold water storage tanks and carry out remedial work where necessary. Check representative taps for temperature, as above, on a rotational basis	Annually
Dental equipment	Drain down and clean	At the end of each working day
Emergency eye wash sprays	Flush through and purge to drain	6-monthly or more frequently if recommended by manufacturers
Mixed-temperature outlets	Check delivery temperature in accordance with D08	6-monthly
Showerheads	Dismantle, clean and descale showerheads and hoses	Quarterly, or as necessary
Sporadically-used outlets	Flush through and purge to drain, or purge to drain immediately before use without release of aerosols	At least twice weekly ⁶

Notes:

* See paragraph 182 in the Health & Safety Commission's Approved Code of Practice L8 for further guidance on tasks that should be undertaken.

1. For effective operation of hot water services, the minimum equilibrium temperature should be 55°C and be achieved within seconds.
2. For thermostatic mixing devices, temperatures should be measured at the inlet.
3. For satisfactory operation of cold water services, temperature equilibrium to below 20°C should be achieved well within one minute.
4. Temperatures should be continuously monitored by the BMS.
5. Additional checks should be made on the hot water circulating system and systems using trace heating at distal points.
6. Risk assessment may indicate the need for more frequent flushing of outlets. It is preferable that this form part of the daily cleaning routine where appropriate. Alternatively, self-purging showers that discharge water to a drain prior to use and without the release of aerosols can be considered.

Microbiological monitoring

- 19.66 Apart from situations where there are taste or odour problems, microbiological monitoring for total viable counts (TVCs) is not considered to be necessary.
- 19.67 If performed for these purposes, the detection of low TVCs is not necessarily an indication of the absence of *Legionella*, but is an indication of the overall water quality and signifies a generally unfavourable environment for bacteria.
- 19.68 All microbiological measurements should be by approved methods and/or be carried out by United Kingdom Accreditation Service (UKAS)-accredited laboratories. Dip slides are not acceptable.

Appendix 1 – Hand-hygiene policy

A hand-hygiene policy must be available within the practice and should contain, at least, the following:

- Carry out hand hygiene between each patient treatment, and before donning and after removal of gloves.
- Bar soap must not be used or made available in the practice.
- Do not use scrub or nail brushes because these can cause abrasion of the skin where microorganisms can reside.
- Nails must be short and clean. Nails should be free of nail art, permanent or temporary enhancements (false nails) or nail varnish.
- Nails should be cleaned using a blunt “orange” stick.
- Use good-quality soft paper hand-towels.
- Ensure that paper towels and drying techniques do not damage the skin.
- Use a hand cream following hand-washing at the end of a session to counteract dryness and as required.
- Hand-washing should take place at least at the beginning and end of every session, and if hands are visibly soiled.
- Antimicrobial handrubs conforming to BS EN 1500 can be used on visibly clean hands as an alternative to washing.
- If hands become sticky with the build of handrub residue, they must be washed as normal using a proper hand-hygiene technique.
- Alcohol-impregnated wipes used for cleaning surfaces should not be used in place of handrubs/gels, as they are not effective in hand decontamination.
- Use a foot-operated or sensor-operated waste bin.

HAND CLEANING TECHNIQUES

How to handrub?

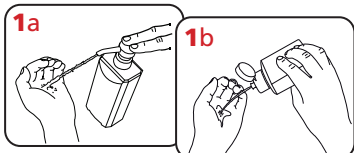

Apply a small amount (about 3ml) of the product in a cupped hand, covering all surfaces



2 Rub hands palm to palm

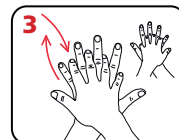

3 Rub back of each hand with the palm of other hand with fingers interlaced

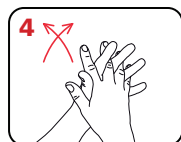

4 Rub palm to palm with fingers interlaced

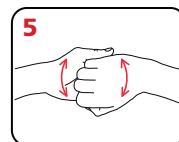

5 Rub with backs of fingers to opposing palms with fingers interlocked

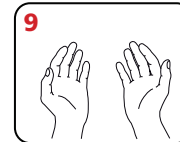

9 Once dry, your hands are safe



How to handwash?

WITH SOAP AND WATER



0 Wet hands with water

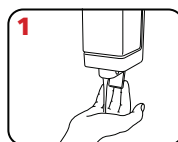

1 Apply enough soap to cover all hand surfaces

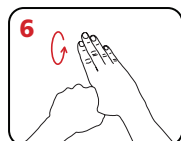

6 Rub each thumb clasped in opposite hand using rotational movement



7 Rub tips of fingers in opposite palm in a circular motion



8 Rub each wrist with opposite hand

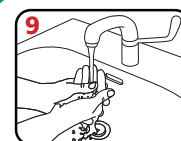

9 Rinse hands with water

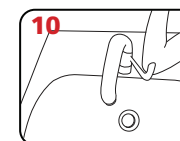

10 Use elbow to turn off tap



11 Dry thoroughly with a single-use towel

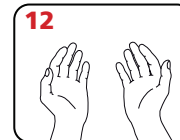

12 Your hands are now safe



Adapted from WHO World Alliance for Patient Safety 2006



Appendix 2 – Examples of logbook pages

Table A1 Summary details

Steam sterilizer details		
Dental practice address	Room	Make
Model	Ref. No	Serial No.

Contents – the following forms:

Name of form	Code	No.	Copy	Purpose	Table
Daily test sheet			Yes	A record of all daily testing	A3
Weekly test sheet plant history record			No	A record of faults/maintenance	A4
Quarterly and yearly test sheets			Yes	Competent Person's (Decontamination) quarterly and yearly test sheets	–
Test history record			Yes	History of the weekly, quarterly and yearly tests	–
Autoclave history record sheet			Yes	Record of all faults, maintenance and repairs to the autoclave	A5
Process log sheet			No	Provides a record of every sterilizer load processed	A6

Personnel	Name/organisation	Tel. No.
Registered manager		
User		
Operator(s)		
Infection control nurse		
Competent Person (Pressure vessels)*		
Authorised Person (Decontamination)		
Competent Person (Decontamination)*		
Service engineer		
Microbiologist		

*These personnel should have qualifications/training/registration defined in CFPP 01-01 Part A

Pressure Systems Safety Regulations 2000

This section to be filled in by the Competent Person (Pressure vessels)

Written scheme of inspection exists/is suitable

Inspection carried out on Date:

Inspected by:

Result of examination/comments

Review of records by Registered Manager or external regulatory body		
Date	Comments on review	Name/signature

Table A2 Daily test sheet

Tests to be carried out in accordance with HTM 01-05

Sterilizer location	Serial No.	Week beginning
Make/model		Ref. No.

	Cycle number	During sterilizing hold period		Sterilizing hold time		Automatic control test result Pass/Fail	Steam penetration test Pass/Fail/Not applicable	Certified fit for use by user
		Temp °C min/ max	Pressure bar	Min	sec			
Mon						P/F	P/F/NA	
Tue						P/F	P/F	
Wed						P/F	P/F	
Thur						P/F	P/F	
Fri						P/F	P/F	
Sat						P/F	P/F	
Sun						P/F	P/F	

Reservoir water changes (where applicable). Drain, rinse and refill with distilled or RO water.			
	Cycle number when water changed	Comments	Water changed by
Monday			
Tuesday			
Wednesday			
Thursday			
Friday			
Saturday			
Sunday			

Faults – new or existing (also enter in plant history record)

Table A3 Weekly test sheet

Tests to be carried out in accordance with HTM 01-05

Sterilizer location	Serial No.	Department
Make/model	Ref. No.	

Week beginning	Cycle number	Automatic air leakage test result* Pass/Fail	Residual air test Pass/Fail	Automatic control test result Pass/Fail	Steam penetration test Pass/Fail/Not applicable	Weekly safety checks Satisfactory/Unsatisfactory	Certified fit for use by user
		P/F	P/F	P/F	P/F/NA	S/U	
		P/F	P/F	P/F	P/F	S/U	
		P/F	P/F	P/F	P/F	S/U	
		P/F	P/F	P/F	P/F	S/U	
		P/F	P/F	P/F	P/F	S/U	
		P/F	P/F	P/F	P/F	S/U	
		P/F	P/F	P/F	P/F	S/U	
		P/F	P/F	P/F	P/F	S/U	

* Only where the sterilizer has an in-built self-test programme. Otherwise the test should be carried out by a CP(D) and copies of the CP(D)'s test sheets should be inserted.

Weekly safety checks (tick if satisfactory)						
Week beginning	Cycle number	Door seal	Door pressure interlock	Door closed interlock	Satisfactory/Unsatisfactory	Tested by
					S/U	
					S/U	
					S/U	
					S/U	
					S/U	
					S/U	

Faults – new or existing (also enter in plant history record)

References

It should be noted that this list may not be totally inclusive at the time of reading. Advice should be sought on the currency of these references and the need to include new or revised documents.

For Northern Ireland variations, see page 95.

Acts and regulations

Carriage of Dangerous Goods and Use of Transportable Pressure Equipment Regulations 2009. SI 2009 No 1348. HMSO, 2009.

<http://www.legislation.gov.uk/uksi/2009/1348/contents/made>

Control of Substances Hazardous to Health Regulations (COSHH) 2002. SI 2002 No 2677. HMSO, 2002.

<http://www.legislation.gov.uk/uksi/2002/2677/contents/made>

Health and Safety at Work etc Act 1974. HMSO, 1974.

Health and Social Care Act 2008. HMSO, 2008.

<http://www.legislation.gov.uk/ukpga/2008/14/contents>

Health and Social Care Act 2012. HMSO, 2012.

<http://www.legislation.gov.uk/ukpga/2012/7/contents/enacted>

Medical Devices Regulations 2002. SI 2002 No. 618. HMSO, 2002.

<http://www.legislation.gov.uk/uksi/2002/618/contents/made>

Pressure Systems Safety Regulations 2000. SI 2000 No 128. HMSO, 2000.

<http://www.legislation.gov.uk/uksi/2000/128/contents/made>

Water Supply (Water Fittings) Regulations 1999.

SI 1999 No 1148. HMSO, 1999.

<http://www.legislation.gov.uk/uksi/1999/1148/contents/made>

Water Supply (Water Quality) Regulations 2010.

SI 2010 No 994. HMSO, 2000.

<http://www.legislation.gov.uk/wsi/2010/994/contents/made>

Codes of Practice

The Health and Social Care Act 2008: Code of Practice on the prevention and control of infections and related guidance. 2010.

http://www.dh.gov.uk/en/Publicationsandstatistics/Publications/PublicationsPolicyAndGuidance/DH_122604

British, European and International Standards

BS 5925:1991. Code of practice for ventilation principles and designing for natural ventilation. British Standards Institution, 1991.

BS 6920-1:2000. Suitability of non-metallic products for use in contact with water intended for human consumption with regard to their effect on the quality of the water. Specification. British Standards Institution, 2000.

BS 8558:2011. Design, installation, testing and maintenance of services supplying water for domestic use within buildings and their curtilages. Complementary guidance to BS EN 806. British Standards Institution, 2011.

BS EN 285:2006+A1:2008. Sterilization. Steam sterilizers. Large sterilizers. British Standards Institution, 2008.

BS EN 556-1:2001. Sterilization of medical devices. Requirements for medical devices to be designated "STERILE". Requirements for terminally sterilized medical devices. British Standards Institution, 2001.

BS EN 556-2:2003. Sterilization of medical devices. Requirements for medical devices to be designated "STERILE". Requirements for aseptically processed medical devices. British Standards Institution, 2003.

BS EN 806-2:2005. Specifications for installations inside buildings conveying water for human consumption. Design. British Standards Institution, 2005.

BS EN 806-3:2006. Specifications for installations inside buildings conveying water for human consumption. Pipe sizing. Simplified method. British Standards Institution, 2006.

BS EN 13060:2004. Small steam sterilizers. British Standards Institution, 2004.

BS EN 61010-1:2001, IEC 61010-1:2001. Safety requirements for electrical equipment for measurement, control and laboratory use. General requirements. British Standards Institution, 2001.

BS EN ISO 11607-1:2006. Packaging for terminally sterilized medical devices. Requirements for materials, sterile barrier systems and packaging systems. British Standards Institution, 2006.

BS EN ISO 15883-1:2006. Washer-disinfectors. General requirements, terms and definitions and tests. British Standards Institution, 2006.

BS EN ISO 15883-2:2006. Washer-disinfectors. Requirements and tests for washer-disinfectors employing thermal disinfection for surgical instruments, anaesthetic equipment, bowls, dishes, receivers, utensils, glassware, etc. British Standards Institution, 2006.

BS EN ISO 17665-1:2006. Sterilization of health care products. Moist heat. Requirements for the development, validation and routine control of a sterilization process for medical devices. British Standards Institution, 2006.

Department of Health publications

Advice for dentists on reuse of endodontic instruments and variant Creutzfeldt-Jakob Disease (vCJD). “Dear Colleague” letter, April 2007.

http://www.dh.gov.uk/en/Publicationsandstatistics/Lettersandcirculars/Dearcolleagueletters/DH_074001

Clean, safe care: reducing infections and saving lives. 2008.

http://www.dh.gov.uk/en/Publicationsandstatistics/Publications/PublicationsPolicyAndGuidance/DH_081650

Note:

The Space for Health website has closed. From April 2013, all DH estates guidance and other materials normally accessed via Space for Health will be available from the individual websites of England, Wales, Scotland and Northern Ireland.

As the details of these individual websites are not currently available, any queries about the status of, and access to, the following DH estates guidance documents should be addressed to help@spaceforhealth.net

This reference list will be updated once the full access details of the migrated guidance documents are established.

Decontamination of reusable medical devices in the primary, secondary and tertiary care sectors – 2007. Clarification and policy summary. 2007.

http://www.dh.gov.uk/en/Publicationsandstatistics/Publications/PublicationsPolicyAndGuidance/DH_074722

Health Building Note 13 – Sterile services department. The Stationery Office, 2004.

Health Facilities Note 30 – Infection control in the built environment. The Stationery Office, 2002.

Health Service Circular (HSC) 1999/178 – Variant Creutzfeldt-Jakob Disease (vCJD): minimising the risk of transmission.

http://webarchive.nationalarchives.gov.uk/+www.dh.gov.uk/en/Publicationsandstatistics/Lettersandcirculars/Healthservicecirculars/DH_4004969

Health Service Circular (HSC) 1999/179 – Controls assurance in infection control: decontamination of medical devices.

http://webarchive.nationalarchives.gov.uk/+www.dh.gov.uk/en/Publicationsandstatistics/Lettersandcirculars/Healthservicecirculars/DH_4004321

Health Service Circular (HSC) 2000/032: Decontamination of medical devices.

http://webarchive.nationalarchives.gov.uk/+www.dh.gov.uk/en/Publicationsandstatistics/Lettersandcirculars/Healthservicecirculars/DH_4002990

Health Service Guideline (HSG) (93)40: Protecting health care workers and patients from hepatitis B.

http://webarchive.nationalarchives.gov.uk/+www.dh.gov.uk/en/Publicationsandstatistics/Lettersandcirculars/Healthserviceguidelines/DH_4084234

Health Technical Memorandum 00 – Policies and principles: best practice guidance for healthcare engineering, 2006.

Choice Framework for local Policy and Procedures 01-01 – Management and decontamination of surgical instruments (medical devices) used in acute care. Part A: The formulation of local policy and choices, 2012.

Choice Framework for local Policy and Procedures 01-01 – Management and decontamination of surgical instruments (medical devices) used in acute care. Part B: Common elements, 2012

Choice Framework for local Policy and Procedures 01-01 – Management and decontamination of surgical instruments (medical devices) used in acute care. Part C: Steam sterilization, 2012.

- Choice Framework for local Policy and Procedures 01-01 – Management and decontamination of surgical instruments (medical devices) used in acute care. Part D: Washer-disinfectors**, 2012.
- Choice Framework for local Policy and Procedures 01-04 – Decontamination of linen for health and social care**. 2012.
- Health Technical Memorandum 04-01 – The control of Legionella, hygiene, “safe” hot water, cold water and drinking water systems**, 2006.
- Health Technical Memorandum 07-01 – Safe management of healthcare waste**. Second edition. 2011.
- Potential vCJD transmission risks via dentistry: an interim review**.
http://www.dh.gov.uk/en/Publicationsandstatistics/Publications/PublicationsPolicyAndGuidance/DH_081170
- Records management: NHS code of practice**. 2006.
http://www.dh.gov.uk/en/Publicationsandstatistics/Publications/PublicationsPolicyAndGuidance/DH_4131747
- Uniforms and workwear: guidance on uniform and workwear policies for NHS employers**.
http://www.dh.gov.uk/en/Publicationsandstatistics/Publications/PublicationsPolicyAndGuidance/DH_114751
- ## Other publications
- BuildCert (2009). **TMV approval scheme**. BuildCert, Gwent.
<http://www.buildcert.com/tmv3.htm>
- Ehrenkranz, N.J., Bolyard, E.A., Wiener, M. and Cleary, T.J. (1980). **Antibiotic-sensitive Serratia marcescens infections complicating cardiopulmonary operations: contaminated disinfectant as a reservoir**. *Lancet*. Vol. 2 No. 8207, pp. 1289–92.
- Health and Safety Commission (2000). **Approved Code of Practice, Legionnaires’ disease: the control of legionella bacteria in water systems (L8)**. Health and Safety Executive, 2000.
<http://www.hse.gov.uk/pubns/priced/l8.pdf>
- Medicines and Healthcare products Regulatory Agency. **DB 9804 (including update sheet, November 2003) – The validation and periodic testing of benchtop vacuum steam sterilizers**. MHRA, 1998.
<http://www.mhra.gov.uk/home/groups/dts-bi/documents/publication/con2015680.pdf>
- Medicines and Healthcare products Regulatory Agency. **MDA DB 2002 (06) (including update sheet, October 2004) – Benchtop steam sterilizers: guidance on purchase, operation and maintenance**. MHRA, 2002.
<http://www.mhra.gov.uk/home/groups/dts-bi/documents/publication/con007327.pdf>
- Meiller, TF et al (1999), ‘Dental unit waterlines: biofilms, disinfection and recurrence’. *The Journal of the American Dental Association*, Vol 130 No 3, January, pp 65–72.
- NHSScotland. **Survey of decontamination in general dental practice**. Sterile Services Provision Review Group, 2004.
<http://www.scotland.gov.uk/Publications/2004/11/20093/45208>
- Pankhurst CL, Johnson NW and Woods RG, Microbial contamination of dental unit waterlines: the scientific argument. *International Dental Journal*, Vol 48, 1998, pp 359–368.
- Pankhurst CL, Woods RG and Johnson NW, Causes and prevention of microbial contamination of dental unit water. *FDI World*, Vol 8 No 1, 1999, pp 6–13.
- Sautter, R.L., Mattman, L.H. and Legaspi, R.C. (1984). **Serratia marcescens meningitis associated with a contaminated benzalkonium chloride solution**. *Infection Control*. Vol. 5 No. 5, pp. 223–225.
- Smith AJ, To flush or not to flush? *Dentistry*, 20 September 2001.
- Walker JT et al, Microbial biofilm formation and contamination of dental-unit water systems in general practice. *Applied and Environmental Microbiology*, Vol 66, 2000, pp 3363–3367.
- Water Regulations Advisory Scheme (WRAS). **Water Fittings and Materials Directory**. WRAS, Gwent, 2005.
- WHO (World Health Organization) (2011). **Water safety in buildings**. WHO, Geneva.
http://www.who.int/water_sanitation_health/publications/2011/9789241548106/en/

Northern Ireland references, equivalents and variations

- The Care Quality Commission and the HCC do not have authority in Northern Ireland. The Department of Health, Social Services and Public Safety (DHSSPS) proposes to register and regulate the private dental sector through the Regional Quality and Improvement Authority (RQIA). Officials from both organisations are progressing this work at present. RQIA have no plans to register the dental sector at present, although this is subject to ongoing review.
- In November 2007, the DHSSPS issued “quality improvement scheme” (QIS) letters outlining priorities for improvements at general dental practices, expecting practices to work towards these within a three-to-five-year time period.
- ‘Decontamination in general dental practices - supplementary guidance’ (issued in November 2007), which includes decontamination room layouts and sterilizer and washer-disinfector model specifications, is available at www.dhsspsni.gov.uk/index/hea/decontamination-general-dental-practices.htm
- Chief Dental Officer’s letters etc can be found at www.dhsspsni.gov.uk/index/dental/dental-whatsnew.htm
- The Northern Ireland equivalent of DB 2000(04) ‘Single use medical devices: implications and consequences of reuse’ is DB 2000/04(NI) available on the NIAIC web site: www.dhsspsni.gov.uk/index/hea/niaic/niaic_device_bulletins.htm
- The Northern Ireland equivalent of DB 2002(06) is DB(NI)2002/06 ‘Benchtop steam sterilizers – guidance on purchase, operation and maintenance’ available at [www.dhsspsni.gov.uk/hea-db\(ni\)2002-06.pdf](http://www.dhsspsni.gov.uk/hea-db(ni)2002-06.pdf)
- The Northern Ireland equivalent of HSC 1999(178) is HSS(MD)15/99 (www.dhsspsni.gov.uk/health-protection-cjd), and of HSC 1999(179) is HSS(MD)16/99 (www.dhsspsni.gov.uk/hssmd15-99.pdf)
- Northern Ireland legislation, policy circulars, codes of practice, device bulletins etc equivalent to those listed throughout this document can be obtained from the following web sites:
 - Ministry of Justice – the UK Statute Law Database provides details of equivalent legislation across the UK (www.statutelaw.gov.uk).
 - The DHSSPS provides policy information including Chief Medical Officer (CMO) circulars (www.dhsspsni.gov.uk).
 - The Northern Ireland Adverse Incident Centre provides access to device bulletins (DB), warning notices etc (equivalent to MHRA publications) (www.dhsspsni.gov.uk/niaic).
 - The Health and Safety Executive for Northern Ireland (HSENI) provides information on Northern Ireland health and safety legislation and codes of practice (www.hseni.gov.uk).
 - On behalf of the DHSSPS, the Estates Policy Directorate of Health Estates issues Professional Estates Letters (PELs). These set out departmental policy in relation to estates issues, including medical devices, non-medical equipment, buildings and plant (www.dhsspsni.gov.uk/index/hea/niaic/niaic_pels.htm).